



OfficeRight™ Document Inserting System DI380



Operator Guide
US/Canada English Version

Statement of FCC Compliance

This equipment has been tested and found to comply with the limits for a Class A digital device, pursuant to part 15 of the FCC rules. These limits are designed to provide reasonable protection against interference when the equipment is operated in a commercial environment. This equipment generates, uses, and can radiate radio frequency energy and, if not installed and used in accordance with the instruction manual, may cause interference to radio communications. Operation of this equipment in a residential area is likely to cause interference, in which case the user will be required to correct the interference at his own expense.

CAUTION: Changes or modifications to this equipment not expressly approved by the party responsible for compliance (Pitney Bowes) could void the user's authority to operate the equipment.

Canada

This class A digital apparatus complies with Canadian ICES-003.

Cet appareil numérique de la classe A est conforme à la norme NMB-003 du Canada.

SV61656 Rev. A ©2006 Pitney Bowes Inc.

All rights reserved. This book may not be reproduced in whole or in part in any fashion or stored in a retrieval system of any type or transmitted by any means, electronically or mechanically, without the express, written permission of Pitney Bowes. We have made every reasonable effort to ensure the accuracy and usefulness of this manual; however, we cannot assume responsibility for errors or omissions or liability for the misuse or misapplication of our products.

Due to our continuing program of product improvement, equipment and material specifications as well as performance features are subject to change without notice. OfficeRight and E-Z Seal are trademarks or registered trademarks of Pitney Bowes.

Table of Contents

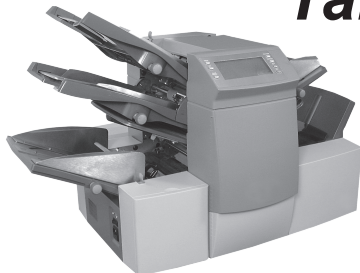

If You Need Assistance

Contact Information for the USA and Canadaiii

Chapter 1 Introduction

Safety	1-2
To The Operator	1-3
Machine Configurations	1-4
Machine Identification	1-5 to 1-7
Control Panel	1-8
Display Symbols	1-9, 1-10

Chapter 2 Operation

About this Chapter	2-1
Connecting Power	2-1
Select a Job	2-2
Run a Trial Piece	2-3
Start Machine Operation	2-3
Setting the Sheet Feeders	2-4, 2-5
Setting the Envelope Feeder	2-6
Setting the Insert Feeder	2-6
Filling the Sealer	2-8
Adjusting the Stacker	2-8
Programming Jobs	2-9
Creating a New Job	2-9
Confirming the Job Setup	2-20
Testing the Job	2-21
Changing an Existing Job	2-22
Deleting a Job	2-22

Table of Contents

Chapter 3 Optical Mark Recognition (OMR)

OMR Availability	3-1
What is OMR?	3-1
A Brief Overview of OMR on your Machine	3-1
Levels of OMR on the System.....	3-2
OMR Mark Positions.....	3-2
OMR Specifications	3-3
OMR Marks Available	3-6
OMR Mark Grouping	3-8
Programming an OMR Job.....	3-10
Adjustment of OMR Scanner.....	3-16
OMR Troubleshooting.....	3-18

Chapter 4 Reference

Changing the Display Language	4-1
Clearing Material	4-1
General Troubleshooting	4-5
Error Messages	4-10
Material Specifications.....	4-13
Machine Specifications.....	4-19

Jobs

Customer Job Programming Record	5-1
---------------------------------------	-----

Appendix A

Glossary of Terms.....	A-1
------------------------	-----

Index

Index to the Operator Guide	Index-1
-----------------------------------	---------

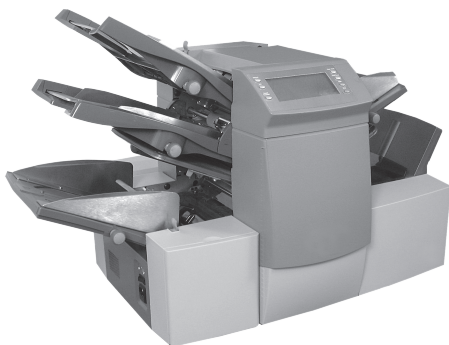

If You Need Assistance

USA Contacts

- Product Name - OfficeRight™ Document Inserting System
- Model - DI380
- For frequently asked questions, go to:
www.pb.com and click on **Customer Support**.
- To place requests for service or training, go to:
www.pb.com and click on **My Account**.
- To order PB supplies and accessories, go to:
www.pb.com and click on **Online Store**.
- To view and pay invoices online, go to:
www.pb.com and click on **My Account**.
- To view inventory, go to:
www.pb.com and click on **My Account**.
- For direct questions, call: 1.800.522.0020. Customer Service Representatives are available Monday through Friday, 8:00 AM to 8:00 PM ET.

Canada Contacts

- Product Name - OfficeRight™ Document Inserting System
- Model - DI380
- For frequently asked questions or to order supplies, go to:
www.pitneybowes.ca
- For direct questions, call: 1.800.672.6937. Customer Service Representatives are available Monday through Friday, 8:30 AM to 4:00 PM ET.

Safety Notes

Follow these precautions whenever you use your inserting system:

- Read all instructions before you attempt to operate the system. Keep the Operator Guide accessible for quick reference.
- Use this equipment only for its intended purpose.
- Place the system close to an easily accessible wall outlet.
- Place the system in an accessible location to allow for proper venting of the equipment and to facilitate servicing.
- Use the power cord supplied with the machine and plug it into a properly grounded wall outlet that is located near the machine and easily accessible. Failure to properly ground the machine can result in severe personal injury and/or fire.
- The power cord wall plug is the primary means of disconnecting the machine from the AC supply.
- DO NOT use a wall outlet controlled by a wall switch or one that is shared with other equipment.
- DO NOT use an adapter plug on the line cord or wall outlet.
- DO NOT remove the ground pin from the line cord.
- Make sure the area in front of the wall outlet into which the machine is plugged is free from obstruction.
- DO NOT route the power cord over sharp edges or trap it between pieces of furniture. Make sure there is no strain on the power cord.
- To reduce the risk of fire or electrical shock, DO NOT attempt to remove covers or disassemble the control panel or its base. The cabinet encloses hazardous parts. If you should damage the unit, contact Your system supplier. Refer to the *Contact Information List* at the front of this guide for more information.
- If the unit becomes damaged, unplug it from the wall, then contact Your system supplier. Refer to the *Contact Information List* at the front of this guide for more information.
- Keep fingers, long hair, jewelry and loose clothing away from moving parts at all times.
- Avoid touching moving parts or materials while the machine is in use. Before clearing a jam, be sure machine mechanisms come to a complete stop.
- Remove jammed material gently and carefully.

1 • Introduction

Safety Notes (Continued)

- Do not place lighted candles, cigarettes, cigars, etc., on the system.
- To prevent overheating, do not cover vent openings.
- Use only approved supplies, in particular aerosol duster. Improper storage and use of aerosol dusters or flammable aerosol dusters, can cause an explosive-like condition that could result in a personal injury and/or property damage. Never use aerosol dusters labeled flammable and always read instructions and safety precautions on the duster container label.
- To obtain supplies and/or Material Safety Data Sheets, contact your system supplier. Refer to the *Contact Information List* at the front of this guide for more information.
- Operation of this equipment without periodic maintenance will inhibit optimum operating performance and could cause the equipment to malfunction. Contact your system supplier for the required service schedule.
- Always follow specific occupational safety and health standards for your workplace.
- To reduce the risk of fire or electrical shock, DO NOT attempt to remove covers or disassemble the control panel or its base. The cabinet encloses hazardous parts. If you should damage the unit, contact your system supplier. Refer to the *Contact Information List* at the front of this guide for more information.

If your stacker has an AC adapter to power the stacker:

- Use only the AC adapter designed specifically for the stacker. Third-party AC adapters may damage the stacker.
- To protect against electrical shock, plug the AC adapter power cord into a properly grounded wall outlet.
- Do not route the AC adapter cable over sharp edges or trap it between furniture.

To the Operator

Your new folding/inserting machine has an easy-to-follow user interface which makes it simple to set up, while offering the following advanced features:

- Envelope seal/no seal option
- Fully automatic material separation on sheet feeders
- Fully automatic settings on fold plates
- Fully automatic envelope separation
- Fully automatic double document detection when selected
- Fold-only option (fold without insertion)
- Manually fed, semi-automatic insertion of single and multiple sheet collations
- Option of single fold, letter (C-fold), accordion (Z-fold) or double fold
- Job recall facility
- Linked feeding (three-station machines only)
- Optical Mark Recognition (OMR) scanning (some models)

Machine Configurations

The following machine configurations are available:

- 1 Station – One sheet feeder only
- 2 Station – One sheet feeder and an insert feeder
- 3 Station – Two sheet feeders and an insert feeder

IMPORTANT: Machine configurations may vary. Some features and options may not be available. This operator guide covers all models and features. However, inclusion in this guide does not guarantee the availability of a particular model, feature or option.

1 • Introduction

Processing speed will vary, depending on machine configuration. See *Specifications* in Chapter 4 for further details.

Some models are equipped with OMR (Optical Mark Recognition) scanning.

An OMR mark is normally a dark solid line on a sheet of light colored paper that is perpendicular to the direction of paper travel. This line must be thick and dense enough to trigger the system's OMR scanner.

The scanner, working with the OMR system software, checks for one or more different OMR marks on a document as it feeds through the system. Tracking of these marks enhances mail piece integrity by assuring that documents that belong together (a set) stay together throughout the inserting process.

OMR-equipped models have scanning heads located on each of the sheet feeders.

Instructions for using OMR functions appear in Chapter 3 of this guide.

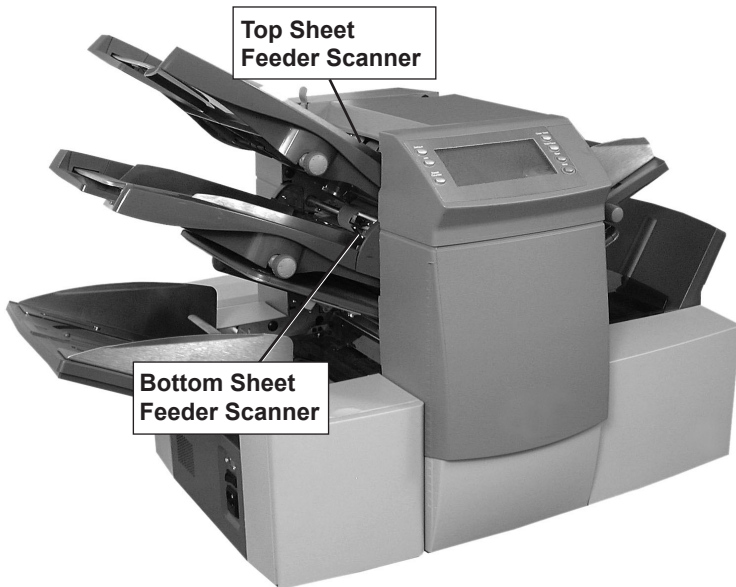

Machine Identification

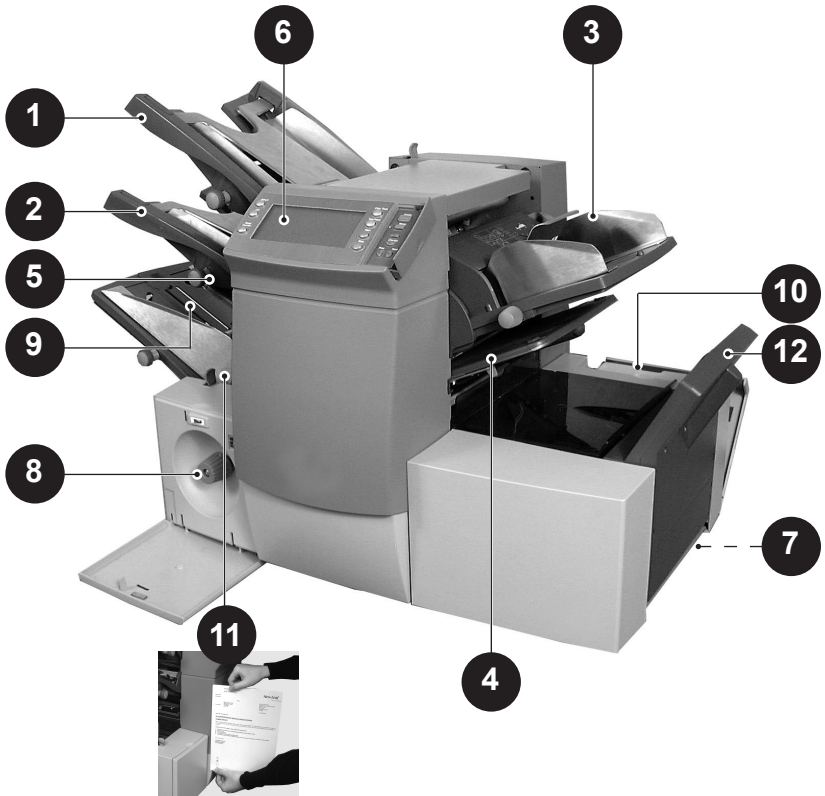

- 1 Sheet Feeder 1** — This feeder is intended for feeding material that requires folding.

In addition, you can set sheet feeder 1 to *Manual Feed*. In this mode, you can run stapled sets of up to five sheets. The machine waits for each set to be manually fed into sheet feeder 1 before folding and inserting the set automatically. See the *Specifications* section of this guide for full details of the sets possible.

- 2 Sheet Feeder 2** — For feeding material that requires folding. Its functions are similar to sheet feeder 1, but manual feed is NOT available from this feeder.

1 • Introduction

Machine Identification (Continued)

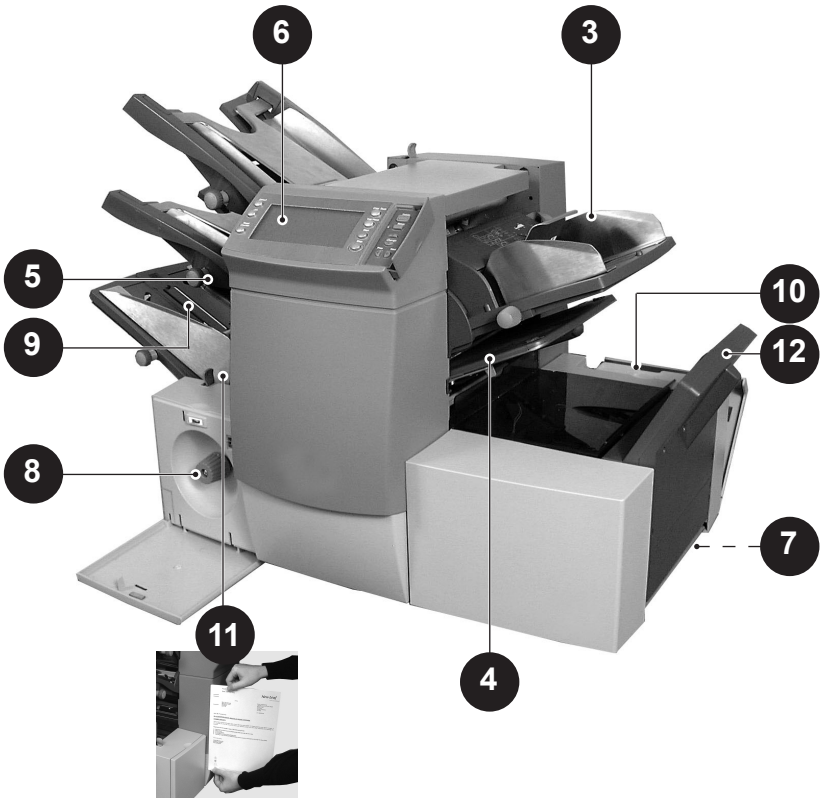

- 3 Insert Feeder** — Use this feeder to add additional inserts to your envelope. Material fed from this feeder cannot be folded by the inserter. However, this feeder is especially suited to feeding pre-folded or thicker inserts.
- 4 Fold Plates 1 and 2** — These create the desired fold in material fed from the sheet feeder(s). The fold plates are automatically set from the control panel.
- 5**
- 6 Display/Control Panel** — This is where you enter commands and where the machine informs you of its status with the use of symbols and icons. Each button function is explained on the following page.
- 7 Drop Stacker or Output Device** (*not illustrated*)
A fold down stacker is located at the exit from the machine to collect the finished mail pieces. This unit can be latched against the machine when not in use. Alternatively, a range of power stackers are available which offer greater capacity than the standard drop stacker.

A mailing machine interface can be installed in place of a stacker. This device automatically transports mail pieces to a Pitney Bowes mailing machine for postage imprinting.
- 8 Manual Advance Knob** — The manual advance knob is located inside an opening cover at the lower center of the machine. Use it to turn the machine mechanisms by hand to help clear a material stoppage.
- 9 Envelope Feeder** — This feeder feeds envelopes into the inserting area where they are filled with material requested from the other feeder(s).
- 10 Sealer Bottle** — The sealer bottle is located inside an opening cover at the front right side of the machine. It provides sealing solution to the envelope sealer.
- 11 Measuring Scale** — The scale is located on the left side of the machine near the sheet feeders. Use it as an aid in measuring material and envelopes.
- 12 Envelope Inverter** — This unit transports the envelope into the stacker *face up*.

1 • Introduction

Control Panel

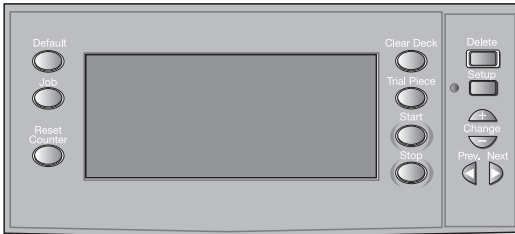

Control Panel Buttons

Default — Press this button to return the machine to its default or 'standard' settings. These settings come pre-configured from the factory but can be modified to suit your needs by a Pitney Bowes Service Representative.

Job — Press to step through the jobs you've programmed into the machine's memory. The machine will store up to 20 jobs. See page 2-9 for details of programming jobs.

Reset Counter — Press to reset the item or batch counter.

Clear Deck — Press to jog material through and out of the system. Use *clear deck* to clear the machine and make it ready for automatic operation after a stoppage has occurred.

Trial Piece — Press to run a single test piece so that you can check machine setup. You **MUST** run a trial piece before you begin automatic operation by pressing the **Start** button. If you're using double detection, the machine sets itself automatically as it runs the trial piece. This envelope will be unsealed and counted as one item.

Start — Starts automatic operation.

Stop — Stops automatic operation at the end of the next cycle.

Delete — Use in setup mode to delete a programmed job from memory.

Setup — Press to enter the machine setup mode. This mode allows you to program jobs into memory for instant recall using the **Job** button.

Change + - In setup mode, press + or - to select options or set values of machine settings.

Prev. ◀ ▶ Next — In setup mode, use these keys to step backward or forward through the various job settings.

Display Symbols



Used on sheet feeders to signify that the feeder is on **without** double detection.



Used on sheet feeders to signify that the feeder is on **with** double detection.



Used on insert feeder to signify that the feeder is on **without** double detection.

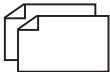

Used on insert feeder to signify that the feeder is on **with** double detection.



Used on sheet feeder 1 to signify that the feeder is set for manual feed.



Used on envelope feeder to signify that the feeder is on.

. . 3 . .

Indicates the setting (from 1 to 5) of the envelope stop.



Indicates that the sealer bottle needs refilling.



Indicates the envelope depth.



Indicates that the sealer unit is off (envelopes not sealed).

1 • Introduction

Display Symbols (Continued)



Indicates that the sealer unit is on (automatic envelope sealing).

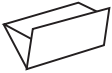

Indicates a C-fold (letter) fold is selected.

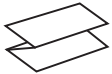

Indicates a Z-fold (accordion) is selected.

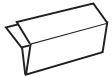

Indicates a double fold is selected.

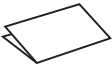

Indicates a single fold is selected.

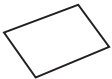

Indicates a no-fold insert operation.



Indicates a material stoppage. The position of this symbol in the display indicates where the stoppage has occurred.



Call for service.

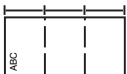

Indicates the paper size, address orientation and fold(s) set for sheet feeder.



Indicates a material stoppage in a downstream device, such as a power stacker or mailing machine Interface (MMI).

About this Chapter

This chapter explains operation of the machine, assuming the job you want to run is *already* programmed into the system.

If you haven't programmed the job, please go to *Programming Jobs* on page 2-9.

Connecting Power



IMPORTANT! Read the safety information on pages 1-1 and 1-2 of this guide *before* you connect the machine.

Connect the power cord to the socket on the left side of the machine.

Plug the power cord into a suitable power outlet. Make sure the power outlet is near the machine and is easily accessible.

Turn the power switch ON.

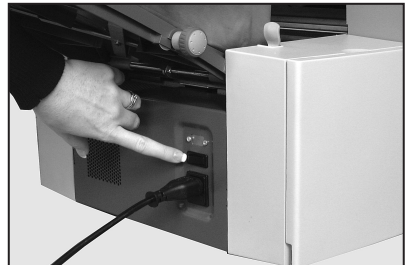

2 • Operation

Select a Job

When the machine is turned ON, the display shows the last job run and “Trial Piece Required”.

Press the **Job** button until the job you require is displayed, or press **Default** if you want to run the machine with your standard job settings.

Note: Only a Pitney Bowes Service Representative can modify the default job.

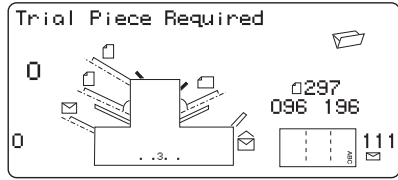

If you have material loaded, press **Trial Piece**. The machine sets itself and runs a test piece for you to check.

If you don't have material loaded, do this now, then return to this section. Loading feeders and related instructions are covered on pages 2-4 to 2-7.

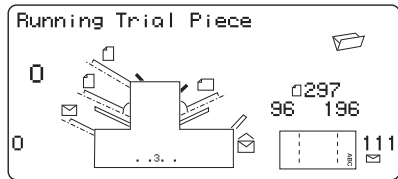

Note:

You may have selected a manual feed job where sheet feeder 1 is set for *manual feed* of collated sets. If this is the case, DO NOT load the sheet feeder; you will feed collated sets one at a time by hand as required by the machine.

For manual feed jobs, pull back the lever as shown in the illustration, right. This opens the feed mechanism, making it ready for manual feed operation.

Remember to return this lever to its normal position when you use the feeder for *automatic* operation.

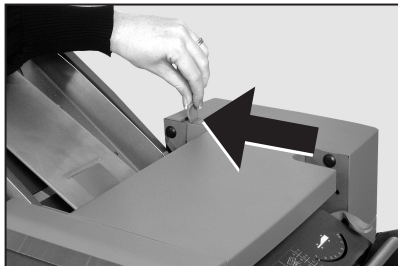

Run a Trial Piece

Once material is in place, press **Trial Piece** so you can check that setup is correct.

You can make minor changes to the job settings at this stage if the trial piece needs fine tuning. Enter setup as described on page 2-9, then use the **Prev** (◀), **Next** (▶) and **Change** (+/-) buttons as required to modify job settings. When you've made the necessary changes, press **Setup** again to return to run mode. The inserter saves the job with the new settings.

Notes:

1. When using linked feeding,* load *both* sheet feeders *before* running a trial piece.
2. If you load material during a run which seems to have different characteristics (weight, color shade, etc.), or if you have any problems with double detection, run another trial piece. This forces the machine to recalibrate the double detect function for the new material in case the batches vary slightly.

Start Machine Operation

Press **Start** to begin automatic operation.

The machine runs until either material runs out or you press the **Stop** button.

Note: If the machine is set for linked feeding, the display shows:
1 > 2 > 1

This confirms that feeding will automatically switch between sheet feeders. See page 2-13 for more details.

* "Linking" is a method of using two feeders such that when one feeder runs out of material, the next "linked" feeder automatically starts feeding. Linking feeders allows you to process a higher volume of material before reloading. Linked feeders are sometimes referred to as "cascading" feeders.

2 • Operation

Setting the Sheet Feeders

1. Adjust the side guides to the width of the material you're running, then back-off a quarter turn on the side guide control. This sets the correct clearance between the guides and the material.



2. Take the stack of paper and aerate it to ensure that individual sheets are not stuck together.

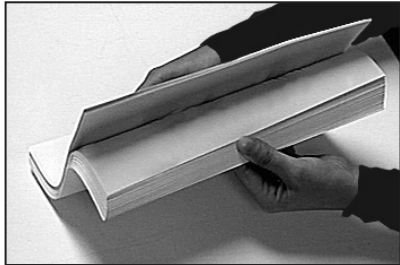

3. Jog the stack back into alignment. The sheet feeders accept the paper stack aligned in a manner similar to that of a photocopier paper cassette.

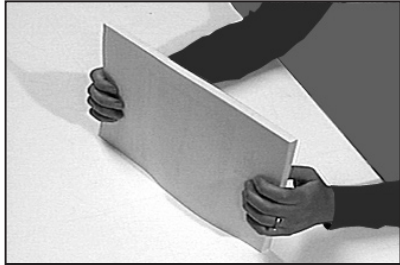

4. The display shows the correct orientation of the paper.

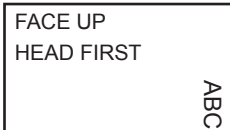

5. Place the paper stack onto the feed deck. Allow the deck to move down and the top of the paper stack to slide under the feed roller.



Note:

When using both sheet feeders for an accordion fold job, always use sheet feeder 2 for the prime (address-bearing) document.

2 • Operation

Setting the Envelope Feeder

The envelope feeder feeds the outer envelope for the inserting job you're running.

1. Adjust the side guides to the width of the envelopes you're running, then back off half a turn on the side guide control. This sets the correct clearance between the guides and the envelopes.



2. Aerate (fan) the stack of envelopes you're running.
3. Place envelopes on the feed deck with their flaps up and trailing.

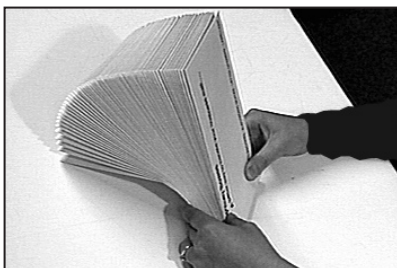

IMPORTANT ! Check that lead edge of the first envelope is under the front feed roller and that the stack of envelopes is shingled on the deck as shown.

Let the wedge slide down behind the stack so that the envelopes are supported.



Setting the Insert Feeder

1. Adjust the side guides to the width of the material being fed, then back off a quarter turn on the side guide control. This sets the correct clearance between the guides and the material.



- Refer to the label located on the insert feeder. Compare your insert with the diagram. Read off the settings for the insert feeder blue lever (numbers 1 to 9) and the separator shield (letters A to D).

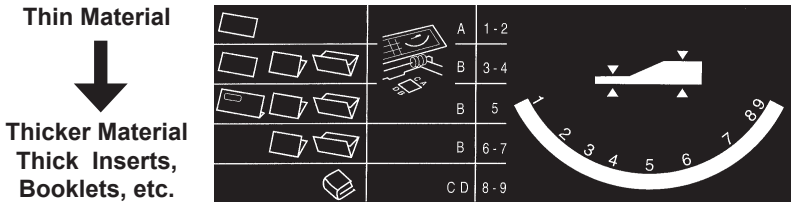

- Set the blue lever to the number required.



- Set the separator shield to the letter required.
- Fan the inserts and place them onto the feed deck. Loading orientation can vary depending on the actual inserts you're running. For many applications we suggest the following:

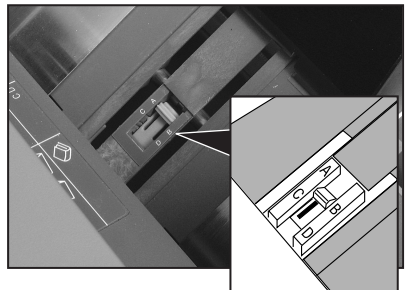

- Slip — Face up, bottom edge first
- Reply Envelope — Face up, top edge first
- Pre-Folded — Face up, closed edge first
- Booklet — Face up, bound edge first

Let the wedge slide down behind the stack so that the inserts are supported.



2 • Operation

Filling the Sealer

When the sealer unit needs refilling, the **Add Sealing Solution** symbol flashes in the display.



Add E-Z Seal® or water in the following way:

Note: We recommend E-Z Seal® to minimize scale buildup and the growth of algae.

Hinge open the sealer bottle cover located at the rear right hand side of the machine. Remove the bottle.

Fill the bottle up to the level indicated.

Put the sealer bottle back in position and close the cover.



Note: If the sealer unit has emptied completely, allow enough time for the solution to soak through the sealer mechanism. This helps assure good seals.

Adjusting the Stacker

Adjust the drop stacker to suit the material you're running.

Lift the lever at the rear of the stacker and adjust the stacker to one of the preset positions. Lower the lever to lock the stacker into position.

When not in use, you can raise and latch the stacker vertically against the exit area of the machine as shown in the photo above.

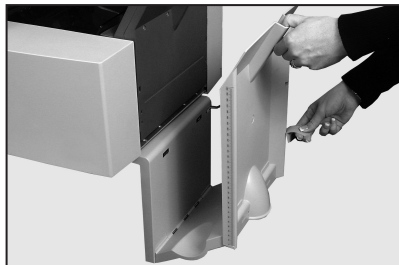

Programming Jobs

You can program your machine with jobs that you can recall at the touch of a button.

All models have 20 operator-programmable jobs plus one default job that your Pitney Bowes Service Representative normally sets.

Creating a New Job

This section takes you step-by-step through the process of setting up a new job and saving it in memory.

Throughout the programming sequence, an asterisk (*) will flash on the display next to the item you're setting. Use the **Prev** (◀) and **Next** (▶) buttons to step forward or backward through the available settings. Once an option displays, use the **Change** (+/-) buttons to select the option or value you want.

Note: Your machine may be equipped with OMR (Optical Mark Recognition) scanning, depending on the model you purchased. To program an OMR job, go to page 3-10 of this guide. To program a non-OMR job, continue by entering the Setup Mode...

Entering the Setup Mode

Open the hinged cover to the right of the display. This exposes the setup buttons.

Press **Setup**. The indicator lights and the machine asks for an access code. This code prevents the machine's settings being changed by unauthorized personnel.

Use the **Change** (+/-) buttons to select the access code **71**.

Press **Next** (▶) to advance to the next setting...

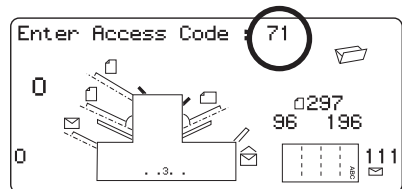

2 • Operation

Choosing the New Job Number

The machine asks for the job number you wish the new settings to be stored under.

Use the **Change (+/-)** buttons to display the job number you want.

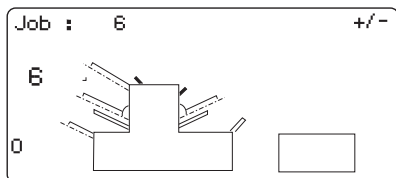
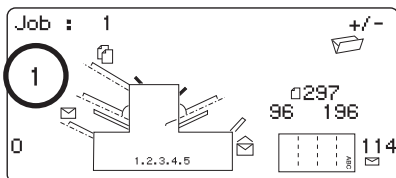

Notes:

- If you use an existing job number, the old settings will be overwritten by the new settings you are about to make.
- If you want to find a currently unused job number, press **Change (+/-)** until you see a job where the display shows no symbols alongside the feeders or in the fold setup area. This means the job number is currently unused.

Press **Next (▶)** to advance to the next setting...

OMR

On models equipped with OMR **ONLY**, the machine will ask you to select the OMR mode. For a non-OMR job, use **Change (+/-)** to select *OMR off* (if you wish to program an OMR job, see page 3-10).

Press **Next (▶)** to advance to the next setting...

Fold Type

Select the type of fold. See the illustrations below.

Press **Change (+/-)** until you see the option you want:

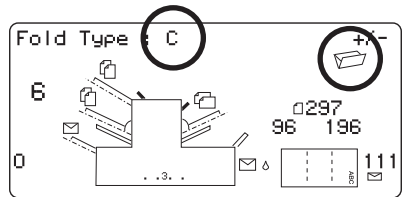

C (Letter)

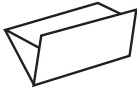

Z (Accordion)

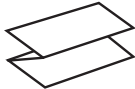

Double

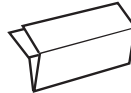

Single

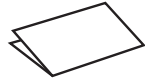

Note: For accumulation jobs, DO NOT manually change the fold length dimensions at the “Fold A” and “Fold B” settings (pages 2-17 and 2-18). The machine sets these automatically.

When you’ve selected the fold type, the display shows the correct orientation for loading paper into the feeders:

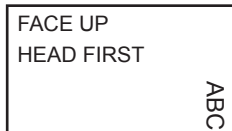

When you’ve set the fold type as required, press **Next (▶)** to advance to the next setting...

2 • Operation

Setting the Accumulation Function

Accumulation, if selected, allows multiple sheets to be fed from the *same* feeder into the envelope.

Press **Change (+/-)** until you see the option you want.

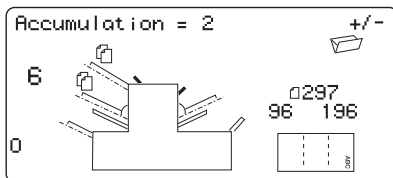

Accumulation: OFF

Accumulation is turned off for this job.

1- and 2-station machines...

Accumulation: ON

Accumulation is turned on for this job.

3-station machines...

Accumulation From Main

Accumulation is turned on with sheets feeding from the main feeder. This feeder normally contains the address sheet.

Accumulation From Suppl

Accumulation is turned on with sheets feeding from the Supplementary feeder (that is, one address sheet from the main feeder followed by multiple sheets from the supplementary feeder).

Press **Next (▶)** to advance to the next setting...

Accumulation = (2 to 10)

Select how many pages you want to feed into each envelope using **Change (+/-)**.

Important: The number of sheets the machine can accumulate is limited by machine specifications. Exceeding this limit can cause the machine to malfunction. See page 4-14 for details.

Setting the First/Main Sheet Feeder

The machine automatically selects the first feeder to set, depending on the fold type selected.

Note: If you're collating different sheets using both sheet feeders, you must load the prime (addressed) document into sheet feeder 1 for **C** and **Double** folds, and into sheet feeder 2 for Z- or single folds. If you're using a single sheet only, you may use either sheet feeder or you can use both by choosing the linked feeder option described below.

Press **Change (+/-)** until you see the option you want:

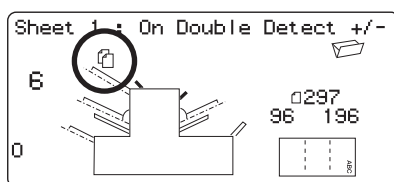

On Double Detect

Feeder on with the double detector operating. (The double detector stops the machine if two or more sheets feed simultaneously from the feeder).

Off

Feeder turned off for this job.



On

Feeder on without the double detector.



Manual Feed

Allows you to manually feed collated sets (only available on sheet feeder 1; also see notes on following page).



Linked: On



Linked: On Double Detect

These functions are available only on the three-station machine. Feed will initially be from the first sheet feeder. When the feeder is empty, the machine automatically switches to feeding from the second sheet feeder.

Load *both* feeders before running a trial piece. This is necessary because each feeder will feed a trial piece.

continued...

2 • Operation

Notes about manual feed:

1. The manual feed setting allows you to run stapled sets of up to five sheets to a maximum of 100 lbs. (400g/m² per set). The maximum compressed thickness of the set *after folding* must not exceed 0.08 inches (2mm). The machine will wait for manual insertion of each set into sheet feeder 1, after which it will fold and insert the set automatically.
2. When running manual feed mode, sheet feeder 2 becomes inoperable.

When the first sheet feeder is set as required, press **Next** (▶) to advance to the next setting...

Setting the Second/Supplementary Sheet Feeder

Select whether you want to use the second sheet feeder.

Press **Change** (+/-) until you see the option you want:

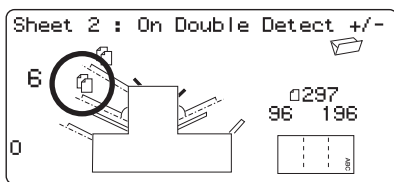

On Double Detect

Feeder on with the double detector operating. (The double detector stops the machine if two or more sheets feed simultaneously from the feeder).



On

Feeder on without the double detector.

Off

Feeder turned off for this job.

When the second sheet feeder is set as required, press **Next** (▶) to go to the next setting...

Setting Insert Feeder

Select whether you want to use the insert feeder and, if so, how it will be used.

Press **Change (+/-)** until you see the option you want:

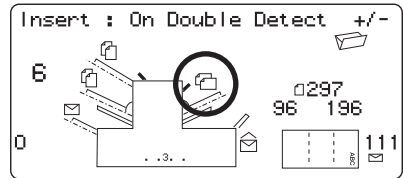

On Double Detect

Feeder on with the double detector operating. (The double detector stops the machine if two or more inserts feed simultaneously from the feeder).



On

Feeder on without the double detector.

Off

Feeder turned off for this job.

When the insert feeder is set as required, press **Next (▶)** to advance to the next setting...

Mode

The machine needs to know if the job requires inserting into an envelope or if it is a fold-only job.

Press **Change (+/-)** to switch between the options:

Insertion Mode

Activates the envelope feeder for a normal inserting job.

Fold-Only Mode

Turns the envelope feeder off and makes the machine act as a folding machine.

When the mode is set, press **Next (▶)** to advance to the next setting...

2 • Operation

Sealer

This setting only appears if an insertion mode has been selected. Select whether you want to seal envelopes or not.

Press **Change (+/-)** to switch the option on or off:



On

Turns the sealer unit on for automatic sealing of envelopes. Make sure the sealer water bottle is full of E-Z Seal® or water (see page 2-10).



Off

Turns the sealer unit off. Envelopes will be ejected unsealed.

When the sealer is set as required, press **Next (▶)** to advance to the next setting...

If you have selected either of the sheet feeders, the next setting offered will be paper length. However, if you are using the insert feeder only, folding is not possible and the display will advance directly to the envelopedepth setting explained on page 2-18.

Paper Length

Select the paper length.

Use the scale on the edge of the front cover.

Quick reference:

A4 paper length: 297mm

US Letter length: 11" (279mm)

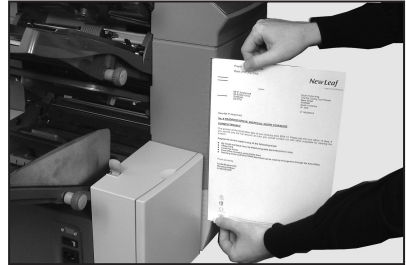

Press **Change (+/-)** until the length of your paper (in millimeters) displays.

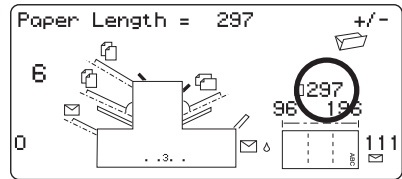

When the paper length is correct, press **Next (▶)** to go to the next setting...

Fold A

Select the size of the first fold required.

Depending on the settings previously made for fold type and paper length, the machine will suggest the correct dimension for the first fold. Most times, therefore, this setting will not require change.

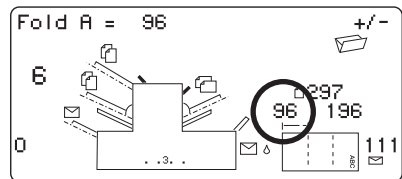

If you want to change the standard setting, press **Change (+/-)** until the length of the fold required is displayed. The symbol | — | shows the fold panel you are adjusting.

The machine will automatically limit your choices to what is physically possible within the machine specifications. (As you change the length of Fold A, you'll see the dimension of Fold B automatically changing to keep within paper Length and machine specifications.)

When the setting is correct, press **Next (▶)** to advance to the next setting...

2 • Operation

Fold B

Select the size of the second fold required.

In a manner similar to that of fold A, the machine suggests the correct dimension for the fold.

If you want to change the standard setting, press **Change (+/-)** until the length of fold required displays. The symbol  shows the fold panel you're adjusting.

When the setting is correct, press **Next (▶)** to advance to the next setting...

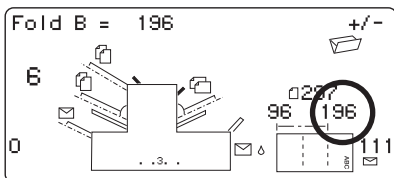

If you're programming an inserting job, the envelope depth setting now appears. If you're programming a fold-only job, the display goes straight to the Confirming the Job Setup section explained on page 2-20.

Envelope Depth

Select the depth of your envelopes (in millimeters).

Again, you can use the scale on the front cover to measure the depth of your envelopes.

Press **Change (+/-)** until the correct dimension is displayed.

When you've set envelope depth as required, press **Next (▶)** to go to the next setting...

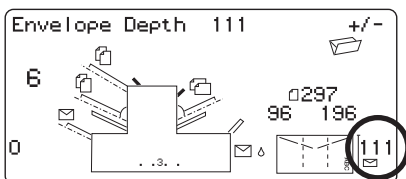

Envelope Stop

Select the position of the machine's envelope stop.

The stop has five positions numbered 1 to 5. Setting 3 is the standard setting for normal weight paper with standard folds. A thinner/lighter insert will require a lower setting and thicker/heavier insert a higher setting.

Press **Change (+/-)** until the setting you want is displayed.

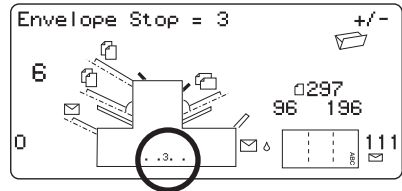

When the envelope stop is set as required, press **Next (▶)** to advance to the next set

Batch Counter

The batch counter allows you to automatically process pre-defined batches of finished mail pieces. When the batch is complete, the machine stops automatically. Press **Start** to begin processing of the next batch.

If batch counter is **not** selected, the display counter simply counts the number of items processed until you press **Reset Counter**.

Press **Change (+/-)** to switch Batch Mode On or Off.

When the setting is correct, press **Next (▶)**.

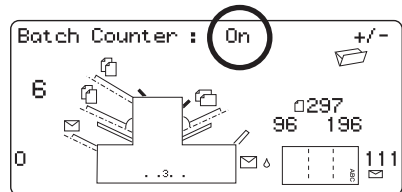

If the batch counter is turned on, the machine will now request the batch quantity. The default quantity is 50, but you may select any value up to 999 using the **Change (+/-)** buttons.

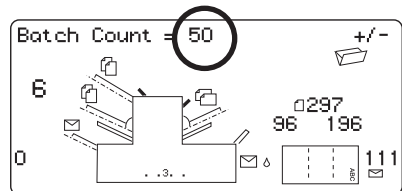

When the setting is correct, press **Next (▶)**.

2 • Operation

Confirming the Job Setup

Job setup is now complete. The display will show the complete job setup for you to confirm.

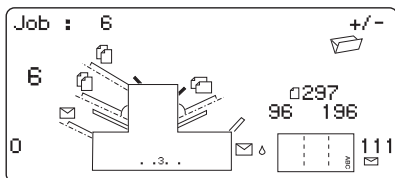

If you see a setting that's incorrect, use the **Prev** (◀) button to back-track to the setting and correct it.

When you're satisfied with the job setup, press the **Setup** button. The machine will save the job in its memory and reset to the new job.

When this is complete, the display will show the new job with the message "Trial Piece Required".

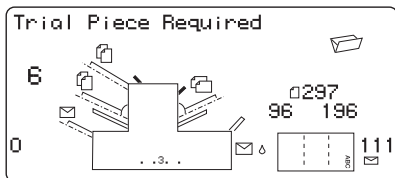

Job settings are retained by the machine *even with power disconnected* until you change or delete them as described on page 2-22.

Testing the Job

Load material and press **Trial Piece** so that you can check if the setup is correct.

You can make minor changes to the job settings at this stage if the trial piece needs fine tuning. Press **Setup**, then use the **Prev** (◀), **Next** (▶) and **Change (+/-)** buttons as required to modify job settings. The chart below will help you fine tune your fold settings.

FOLD TYPE	ADDRESS TOO LOW	ADDRESS TOO HIGH
C - Letter Fold	Decrease Fold A	Increase Fold A and increase Fold B by the same amount
Z - Accordion Fold	Increase Fold A	Decrease Fold A a increase Fold B by the same amount
Single Fold	Increase Fold A	Decrease Fold A
Double Fold	Decrease Fold A	Increase Fold A

We suggest that you change folds by 0.20 inches (5mm) each time and run a new trial piece run to test the settings.

When you've made the necessary changes, press **Setup** again to return to run mode. The machine will save the job with the new settings.

2 • Operation

Changing an Existing Job

To change an existing job:

1. Enter the setup mode as described on page 2-9.
2. Use the **Change (+/-)** buttons to display the job you wish to edit.
3. Use the **Prev (◀)** and **Next (▶)** buttons to display the setting(s) you wish to change.
4. Use the **Change (+/-)** buttons to change the options/dimensions you wish to amend.
5. Press the **Setup** button to leave the setup mode and save the changes.

Deleting a Job

To erase an existing job from memory:

1. Enter the setup mode as described on page 2-9.
2. Use the **Change (+/-)** buttons to display the job you wish to delete.
3. Press the **Delete** button. The display reads “Press again to confirm”. Press **Delete** again. The display will briefly read ‘Deleting Job’ as the job is erased.
4. Press the **Setup** button to leave setup mode.

OMR Availability

Your machine may be equipped with Optical Mark Recognition (OMR) scanning, depending on the model you purchased.

All models have 20 Operator programmable jobs plus one default job your Pitney Bowes Service Representative normally sets.

What is OMR?

An OMR mark is normally a dark solid line on a sheet of light colored paper that is perpendicular to the direction of paper travel. This line must be sufficiently thick and dense to trigger the OMR scanner on the system.

The OMR scanner, working with the OMR system software, checks for one or more different OMR marks on a document as it feeds through the system. The tracking of these marks enhances mail piece integrity by assuring that sheets which belong together actually stay together throughout the entire inserting process.

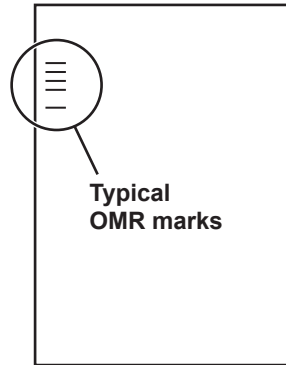

Use the **Prev** (◀) and **Next** (▶) buttons to step forward or backward through the settings available. Once the item displays, use the **Change** (+/-) buttons to select the option you want.

A Brief Overview of OMR on Your Machine

One sheet feeder holds sheets with OMR marks:

- Sheet feeder 1 for C-fold and double fold applications
- Sheet feeder 2 for Z-fold and single fold applications

The sheet feeder holding the sheets with OMR marks can feed multiple sheets per envelope.

The sheet feeder not holding OMR sheets can hold supplementary sheets that you can place under the selective control of the OMR sheets.

3 • OMR

You can also set up the insert feeder to be under the selective control of the OMR sheets. As a result, you can use OMR to fill an envelope with a variable number of sheets from one feeder, with or without a supplementary sheet and an insert.

A supplementary sheet and folded insert will be nested with the first sheet in the envelope. Because OMR allows each envelope to contain tailored contents, the last sheet in the envelope will include address information for use with windowed envelopes to ensure that each set of sheets is addressed to the correct recipient.

OMR on this system uses extensive error checking. This means insertion accuracy is very high: the probability of the wrong set of sheets being inserted into an envelope is low.

Levels of OMR on the System

Basic OMR enables you to collate multi-page documents that vary in number of sheets. It allows you to vary the number of pages per envelope in a run from one envelope to another through the use of OMR marks. The machine will fold each OMR sheet separately and insert it into an envelope, starting with the last sheet of the set and adding each folded sheet in turn until the address sheet has been inserted. The machine will then eject the envelope after sealing (if selected).

Enhanced OMR allows you to stop feeding sheets at selected points in a run and/or to select whether the other feeders are used. It also provides a higher level of mail piece integrity so that sensitive documents are not sent to the wrong customer.

OMR Mark Positions

To enable the inserter's OMR scanners to read the printed OMR marks, the marks **MUST** be positioned within a defined range of positions on the page.

Standard OMR positions are given in the diagram on page 3-4.

Offset OMR positions allow the marks to be positioned further down the page. Specifications are given in the diagram on page 3-5. To use Offset OMR, you must select one of the offset OMR functions when programming the OMR job. See page 3-10 for full details.

OMR Specifications

The mark must be a solid black line between 1pt and 2pts thick (0.014 inch [0.35mm] to 0.027 inch [0.7mm]) and at least 0.393 inch (10mm) wide.

Each mark position must be evenly spaced and at least 0.118 inch (3mm) apart.

An area around the marks should be kept clear from print and any other marks that might be read by the scanner in error. This area is called the clear zone.

There should be no print on the opposing face of the sheet immediately behind the clear zone.

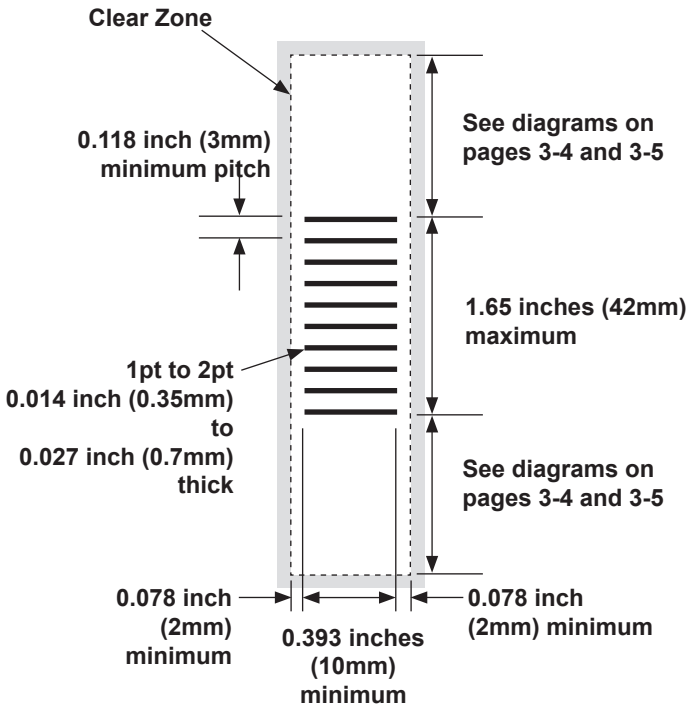

Note: Diagram is not to scale

3 • OMR

Standard OMR Positions

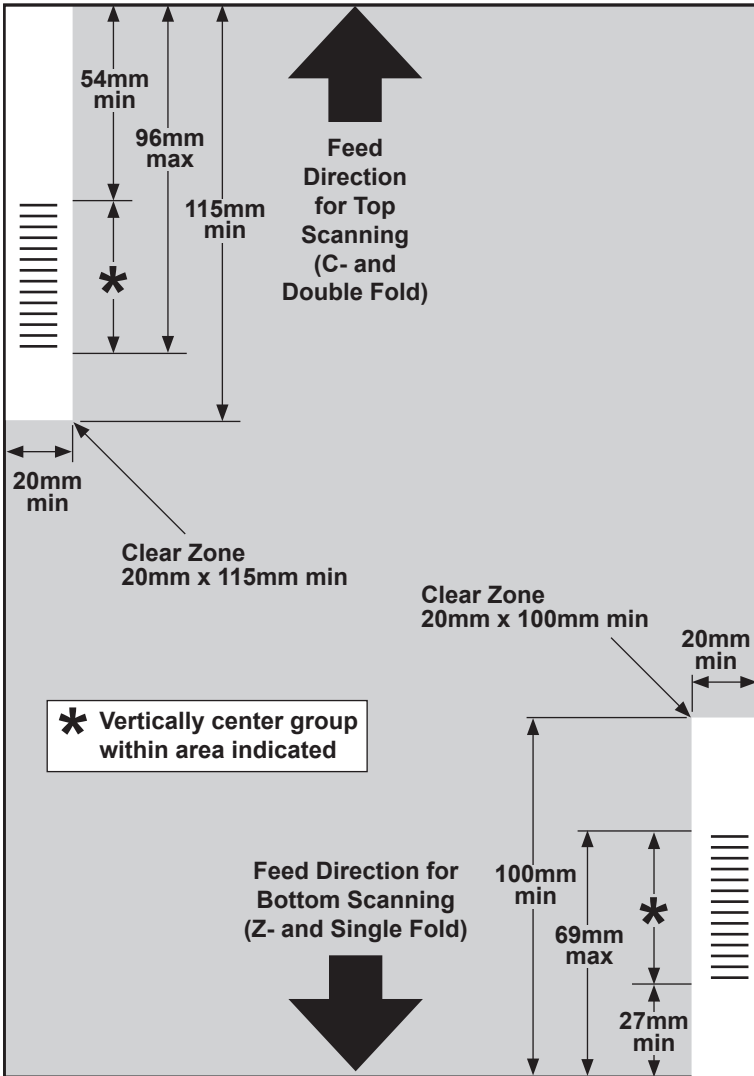

Position OMR marks as follows:

- C-Fold and Double Fold: Top scanning, top left corner
- Z-Fold and Single Fold: Bottom scanning, bottom right corner

Note: Diagram not to scale

Offset OMR Positions

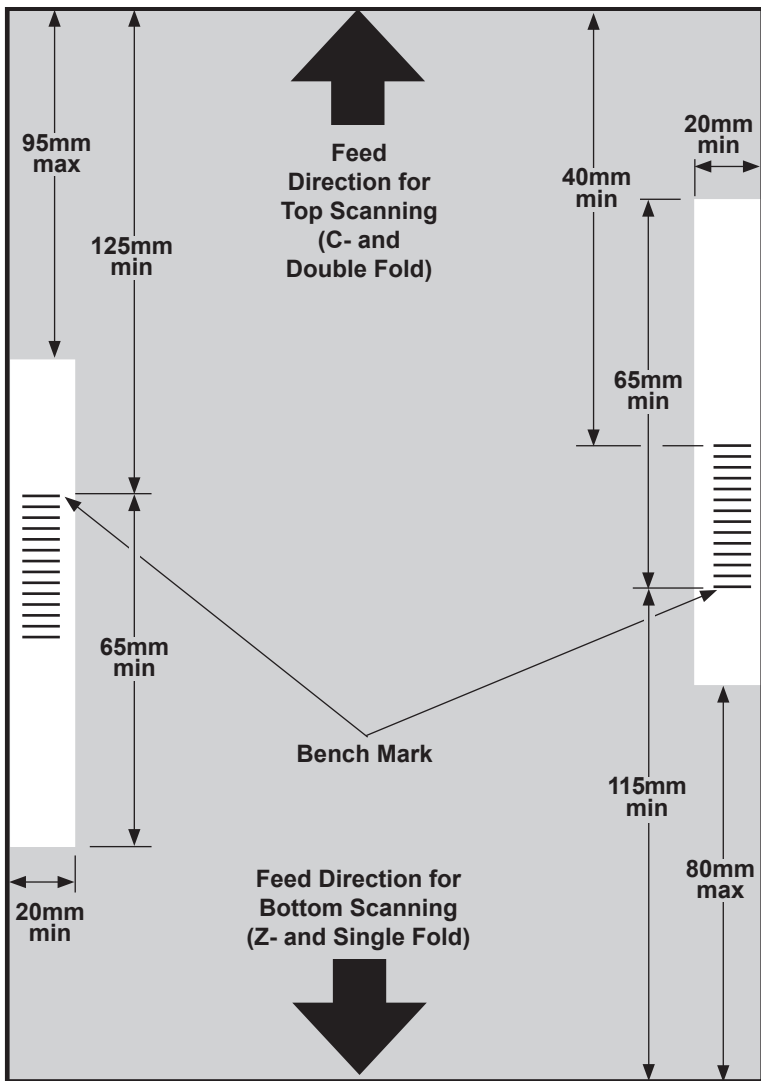

Position OMR marks as follows:

- C-Fold and Double Fold: Top scanning, left margin
- Z-Fold and Single Fold: Bottom scanning, right margin

Note: Diagram is not to scale

3 • OMR

OMR Marks Available

This section gives brief descriptions of the OMR marks that can or must be allocated to an OMR Code.

Note: Some marks within this section are available as added features which expand OMR capability. Contact your local Pitney Bowes office for details. OMR features will vary, depending on the options you purchased.

Benchmark

This is a mandatory mark. It must be the *first* mark of the code and will appear on *every* page within the set.

Safety

This is a mandatory mark that improves the integrity of your mail piece. It is automatically placed immediately after the benchmark.

End-of-Collation (EOC)

This mark indicates that it is the *last sheet fed within the collation/set* (the address sheet).

Your system operates on the absence of this mark, that is, the action will take place if the mark is NOT read by the scanner. It is therefore indicated on the OMR code as **Not EOC**.

Beginning-of-Collation (BOC)

This mark indicates that it is the *first sheet fed within the collation/set*.

Your system operates on the absence of this mark, that is, the action will take place if the mark is NOT read by the scanner. It is therefore indicated on the OMR code as **Not BOC**.

Parity

This mark is a security feature, that when printed, always makes the number of marks total an even number. If any one of the marks within the code is missed during scanning, the machine will stop, allowing the operator to correct the error.

Retiming Mark

This mark is mandatory in each group of OMR marks making up the code (see later in this section for an explanation of OMR mark grouping).

It allows the machine to recalibrate for accurate scanning. Retiming marks count in the parity calculation.

Select Feed (SF1, SF2)

These marks are used to control the feed of material from the feeder holding the supplementary sheets/inserts on a set-by-set basis. Therefore you cannot use select feed on a single station machine.

Select Feed 1 marks are used in the primary sheet feeder to select material from the supplementary sheet feeder. For C- and double folds, the primary feeder is sheet feeder 1. For Z- and single folds, the primary feeder is sheet feeder 2.

Select Feed 2 marks are used in the primary sheet feeder to select material from the Insert feeder. For C- and double folds, the primary feeder is sheet feeder 1. For Z- and single folds, the primary feeder is sheet feeder 2.

Auto Batch

This mark identifies the last set of a batch, when the batch function is in use. It must be printed on all sheets of the OMR set that requests this function.

Wrap Around Sequence (WAS1, WAS2, WAS3)

This is a numbering system which uses sequential binary coding. If a page is missing or the set goes out of sequential order, the system will stop processing and declare an error.

Three wrap around sequence marks are used within the code. The use of three binary digits allows a decimal count of 0 to 7. Pages will be numbered from 0 up to 7 and then back to 0 on a continuous cycle throughout the print run.

3 • OMR

OMR Mark Grouping

Each OMR code begins with two fixed marks at the end nearest to the sensor (benchmark and safety mark). These are followed by one, two, or three groups of marks where each group comprises three data marks followed by a fixed mark. Each data mark is present or absent as required to reflect the function desired. Each code must end with a retiming mark.

Basic OMR mode uses only Group 1.

Enhanced OMR mode uses Group 1 plus Group 2 and/or Group 3, as needed for a particular job.

C-Fold and Double Fold Jobs

Place marks in the upper left corner of the sheet. Print marks in top-to-bottom order:

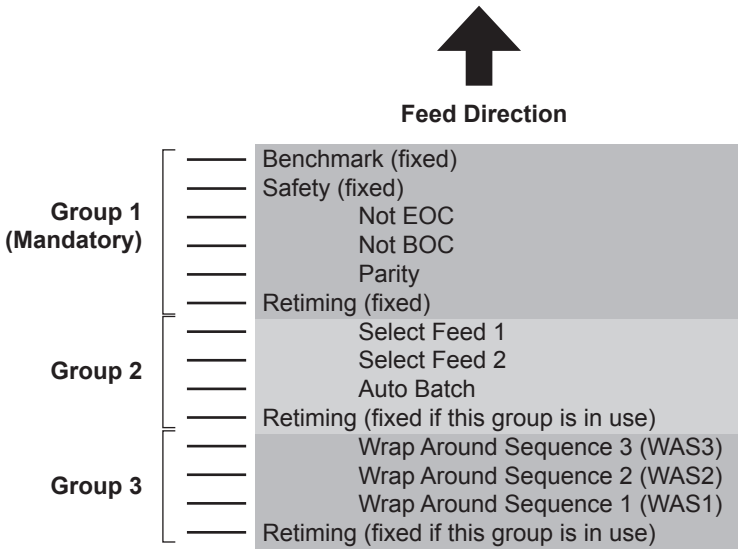

Print sheets in reverse collation order. In this way, the last sheet processed in each set is the address sheet and the first sheet processed is the last of each set.

Z-Fold and Single Fold Jobs

Place marks in the lower right corner of the sheet. Print the marks in bottom-to-top order:

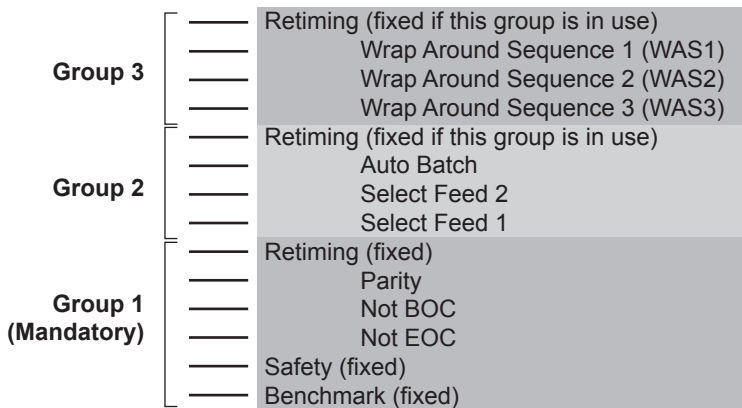

Feed Direction



Print sheets in normal collation order. In this way, the first sheet processed in each set is the address sheet and the last sheet processed is the last of each set.

Programming an OMR Job

Entering the Setup Mode

Open the hinged cover to the right of the display. This exposes the setup buttons.

Press **Setup**. The indicator lights and the machine asks for an access code. This code prevents unauthorized personnel from changing the machine's settings.

Use the **Change (+/-)** buttons to select the access code **71**.

Press **Next (▶)** to advance to the next setting...

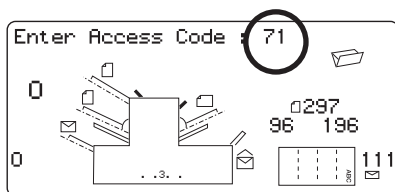

Choosing the New Job Number

The machine asks for the job number you wish the new settings to be stored under.

Use the **Change (+/-)** buttons to display the job number you want.

Notes:

- If you use an existing job number, the old settings will be overwritten by the new settings you are about to make.
- If you want to find a currently unused job number, press **Change (+/-)** until you see a job where the display shows no symbols alongside the feeders or in the fold setup area. This means the job number is currently unused.

Press **Next (▶)** to advance to the next setting...

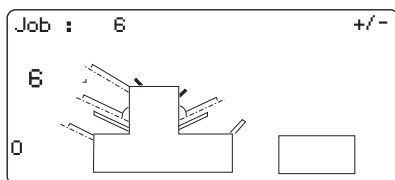
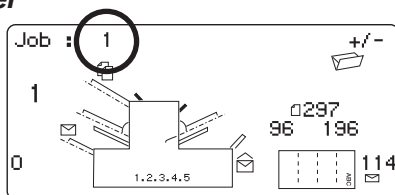

Selecting the OMR Functions

Press **Change (+/-)** until you see the option you want. Note that the options shown will depend on the OMR functionality that your machine has. Details of *standard* and *offset* OMR positioning appear on pages 3-4 and 3-5.

OMR off

OMR is turned off for this job.

OMR on

OMR is turned on (Basic Scanning) for this job with *standard* OMR mark positioning.

OMR + Sequence

Basic scanning + Wrap Around Sequence scanning for this job with *standard* OMR mark positioning.

OMR + Select feed

Basic scanning + Select Feed/Autobatch scanning for this job with *standard* OMR mark positioning.

OMR + Select feed + Sequence

Basic scanning + Select Feed/Autobatch + Wrap Around Sequence scanning for this job with *standard* OMR mark positioning.

OMR Offset on

OMR is turned on (Basic Scanning) for this job with *offset* OMR mark positioning.

OMR Offset + Sequence

Basic scanning + Wrap Around Sequence scanning for this job with *offset* OMR mark positioning.

OMR Offset + Select feed

Basic scanning + Select Feed/Autobatch scanning for this job with *offset* OMR mark positioning.

OMR Offset + SF + Sequence

Basic scanning + Select Feed/Autobatch + Wrap Around Sequence scanning for this job with *offset* OMR mark positioning.

continued...

3 • OMR

Notes:

OMR (Basic scanning) offers the following scanning

functions:

- Benchmark
- Safety
- End-of-Collation absent
- Beginning-of-Collation absent
- Parity
- Retime

Select feed/autobatch offers the following scanning

functions:

- Select feed 1
- Select feed 2
- Autobatch
- Retime

Sequence offers:

- Three wrap-around page sequence marks
- Retime

The maximum pages per set that can be fed from either sheet feeder 1 or 2 when using the OMR function must fall within the limits detailed on page 4-14 of this guide.

Press **Next** (▶) to advance to the next setting...

Fold Type

Select the type of fold.

Press **Change (+/-)** until you see the option you want:

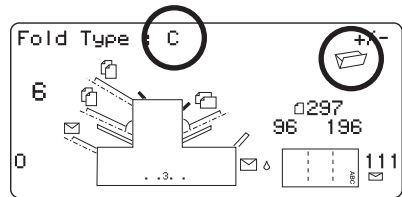

Note: For OMR scanning jobs, DO NOT manually change the fold length dimensions for Fold A and Fold B. These are set automatically by the machine.

C — Letter

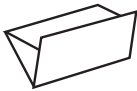

Z — Accordion

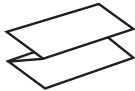

Double

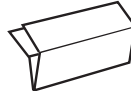

Single

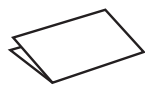

When you select either a C-fold or a double fold, the machine automatically selects top sheet feeder 1 as the scanning feeder. If you select either a Z- fold or a single fold, the machine automatically selects the bottom sheet feeder 2 as the scanning feeder.

The display shows the correct orientation for loading paper into the feeders:

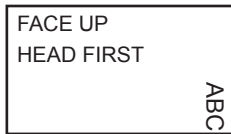

When the fold type is set as required, press **Next (▶)** to advance to the next setting...

3 • OMR

Setting the Main (Scanning) Sheet Feeder

Press **Change (+/-)** until you see the option you want:

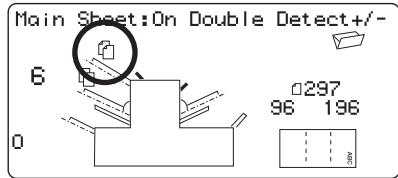

On Double Detect

Feeder is on with the double detector operating. (The double detector stops the machine if two or more sheets feed simultaneously from the feeder.)



On

Feeder on without the double detector.

When the Sheet Feeder is set as required, press **Next (▶)** to advance to the next setting...

Setting Select/Supplementary Feeders

Press **Change (+/-)** until you see the option you want:

If sheet feeder 1 is the main/scanning feeder, you can program sheet feeder 2 and/or the insert feeder for normal (one per envelope) feeding or select feeding.

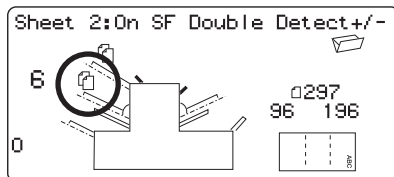

If sheet feeder 2 is the main/scanning feeder, you can program sheet feeder 1 and/or the insert feeder for normal (one per envelope) feeding or select feeding.

Select feed allows the machine to feed one piece *selectively* from either feeder per envelope.



On Double Detect

Feeder on with the double detector operating, without select feed. (The double detector stops the machine if two or more sheets feed simultaneously from the feeder.)



On SF Double Detect

Select feeder on with the double detector operating. (The double detector stops the machine if two or more sheets feed simultaneously from the feeder.)



On SF

Select feeder on without the double detector.

Off

Feeder turned off for this job.



On

Feeder on without the double detector or select feed.

When the feeder is set as required, press **Next (▶)** to go to the sealer setting. Job programming then follows the normal sequence described from page 2-16 of this guide.

3 • OMR

Adjustment of OMR Scanner

In order for OMR scanning to work correctly, it is important to ensure that the scanning heads are positioned in line with the scan dash (OMR) marks printed on the material.

To locate the scanning head for the top sheet feeder 1, open the top cover. You'll find the scanning head at the rear of the machine.

To locate the scanning head for the bottom sheet feeder 2, remove both sheet feeder 2 and the fold plate situated below sheet feeder 2. You'll find the scanning head mounted at the front of the machine.

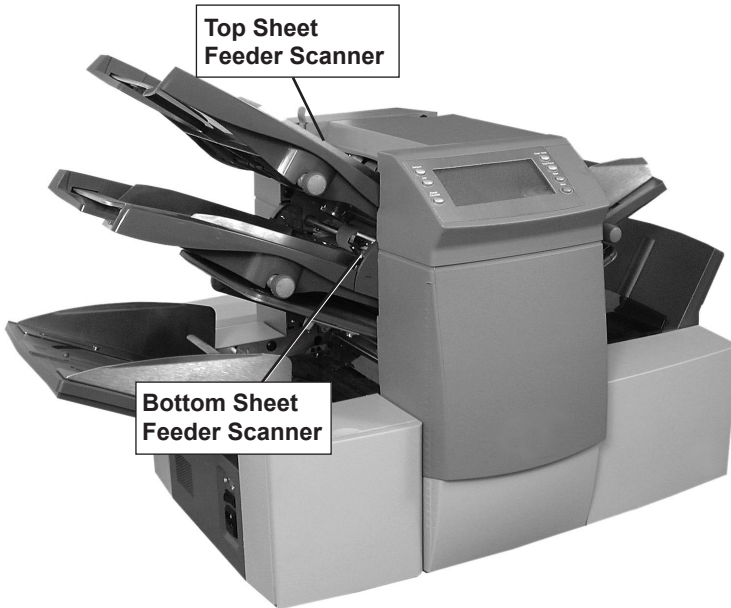

Fold a sheet of material in half and measure the distance from the side of the form to the middle as shown.

For an A4 size form, this measurement is 105mm. For a letter-size sheet (8.5 x 11 inches), it is 108mm.

Now measure the distance from the edge of the form to the middle of the scan dash marks, as shown. Then subtract this measurement from the half-fold measurement.

Example:

For an A4 size form, the half fold measurement is **105mm**.

If the distance from the edge of the form to the middle of the scan dash marks is **10mm**, the scanning head setting will be **95mm** (105mm minus 10mm).

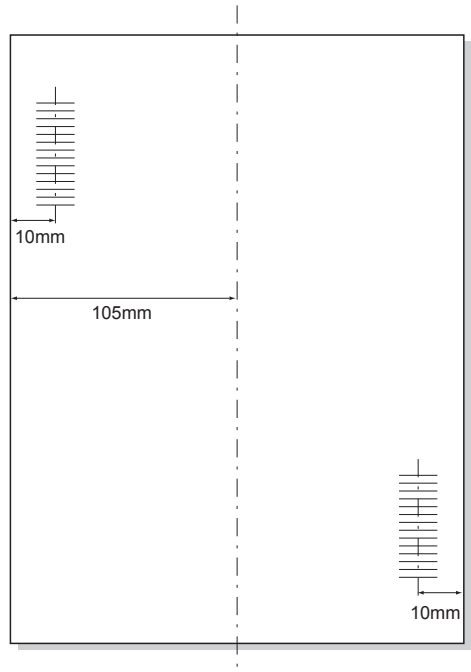

Loosen the knurled locking knob and set the relevant scanning head to the correct setting.

Retighten the locking knob.

If you've adjusted the bottom sheet feeder scanner, install both sheet feeder 2 and the fold plate located below sheet feeder 2.

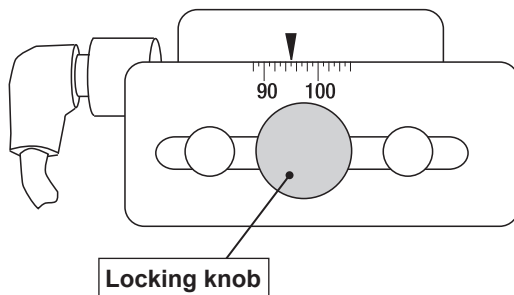

OMR Troubleshooting

Error Recovery for OMR Jobs:

If the machine stops during an OMR job, and indicates one of the error messages listed below, press the **Clear Deck** key. Any envelope at the insertion area will eject into the stacker. The remaining pages of the current set will feed/fold and eject into the stacker. You can insert them into the envelope by hand. The first page of the next set will prefeed into the feed rollers and stop. Pull back the sheet to the normal feed position and continue to run.

Error Recovery for Accumulation Jobs:

If the machine stops during an accumulation job, press the **Clear Deck** key. The envelope at the insertion area will eject into the stacker. You must remove the remaining pages of the set from the appropriate feeder by hand and fold the set and place it into the envelope. Resume operation once you've determined the cause of the stoppage.

Error Recovery for Empty Feeders:

If any feeder runs out of material the machine will stop, and the following messages will scroll across the display...

“Re-fill Empty Tray”

then...

“Press START to Continue”

or...

“Press STOP and Clear Deck”

Reload the feeders and proceed as required.

OMR Error Messages

<i>Message</i>	<i>Action</i>
Bad OMR marks Spacing	Two marks are read which are closer together than half the expected distance. Check scan marks on material.
No OMR marks	No marks on paper. Scan sensor not positioned centrally over the scan marks. Paper not loaded correctly.

<i>Message</i>	<i>Action</i>
Bad OMR Code length	Code type on paper does not match the set-up. Example: setup has OMR+ Sequence but paper has OMR + Select Feed + Sequence.
Bad OMR Code format	A re-timing scan mark is missing. Check material. Example: mark 6 is missing from a 10 mark code.
Expected 1st Sheet of set	The BOC mark (position 4) was present when it was not expected. First page of the set was expected.
Not a new Envelope	The BOC mark (position 4) was absent when it was expected. Pages other than the first page of the set were expected.
OMR: Parity Error	The code does not have an EVEN number of marks.
OMR: Sequence Error	The sequence number is not sequential with the previous page fed. Sheets are in the wrong order or missing.
OMR: SF marks Inconsistent	The Selective feed and Autobatch marks at positions 7 to 9 are different from those on the previous sheet of this set.
OMR: SF not in Use	A selective feed mark is present at positions 7 to 8, but the job setup does not include select feed.
OMR: Set too Large	The set contains too many sheets from the main feeder.
OMR: End of Batch Ready to Run	This indicates that the machine has stopped for "End of Batch". This allows the operator to manually sort envelopes.
Mode Change Recheck Feeders	Check the sheet and insert feeder settings against the job you're loading before exiting the setup mode.

Changing the Display Language

To change the language of the display...

1. Open the hinged cover to the right of the display. This exposes the setup buttons. Press **Setup**. The indicator lights and the machine asks for an access code.
2. Use the **Change (+/-)** buttons to select the access code **99**.
3. Press **Next (▶)** to select the languages option.
4. Use the **Change (+/-)** buttons to scroll through the languages. When your required language is displayed, press the **Setup** button to select the language and leave the setup mode.

Clearing Material

Note: All the following illustrations show the three-station machine; other models are similar.

The machine is designed to assure maximum performance. In the event of a material stoppage, the display flashes a symbol indicating where the stoppage has occurred. First press **Clear Deck** to attempt to feed the material through the machine. If this is not successful, the sections below tell you how to remove the trays and plates to gain access to the material.

The Manual Advance Knob

Having located the material, you may need to use the Manual Advance Knob to manually feed paper out of the grip of feed rollers.

The Manual Advance Knob is located behind the drop down cover at the left front of the machine as shown at the right.



4 • Reference

Removal and Replacement of the Sheet Feeder Trays

To remove...

Lift the rear of the tray slightly and pull it straight out from the machine.

Note:

If the tray is loaded, gently hold the material in place to prevent it sliding forward as you remove the tray.



To replace...

Place the tray into its location guides in the side frames. Lift the rear of the tray slightly and push it into the machine. The tray will automatically drop into its correct position.

Removal and Replacement of the Fold Plates

To remove...

Pull the two catches on the underside of the plate outward to release them. Pull the plate straight out of the machine.

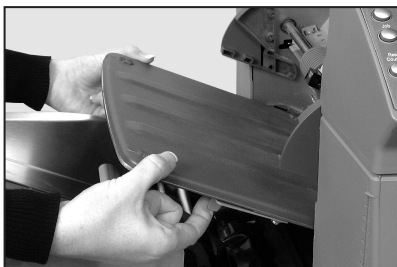

To replace...

Pull the two catches on the underside of the plate outward to release them. Slide the plate into its location guides and release the catches to lock the plate in position.

Removal and Replacement of the Insert Tray

To remove...

Pull the insert tray straight out from the machine.

To replace...

Slide the tray into its location guides and push until it clicks into place.



Access to Carriage Assembly

(Two- and Three-station machines only).

You can pull the carriage assembly outward to gain access. Remove the insert feeder and fold plate 2 first.

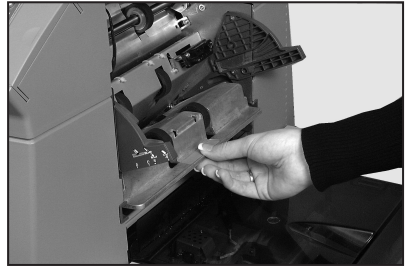

Access to Envelope Feeder Area

To gain access...

Pull the release lever in the direction of the arrow, right.

Lift the envelope area feed rollers to gain access.

To relatch feed rollers...

Release the envelope area feed rollers and let them rest in position.

Push the rollers firmly down until they latch into position.

Note: You can get better access to this area by removing fold plate 1 and sheet feeder 2.

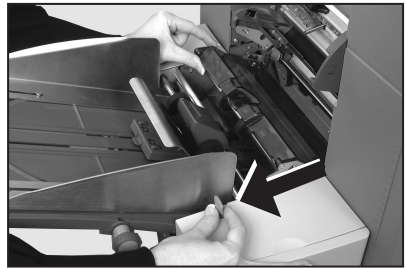

Access to the Envelope Exit Area

Pull down the access door as shown at the right to gain access to jammed material.

When you close the access door, make sure to latch it firmly in position.

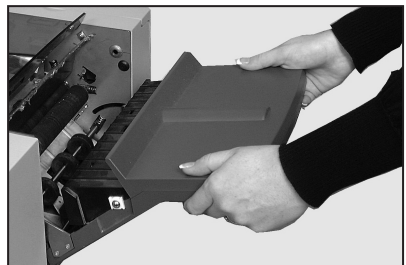

4 • Reference

Access to the Envelope Inserting/Sealing Area

You can access the insertion and sealing areas by lifting the tinted plastic cover and lowering the envelope inverter access door. See the figure, right.



Access to the Sheet Feed Area

To gain access...

Open the top cover.

Squeeze the two blue handles together and pivot the guide assembly to the right to gain access.

To relatch...

Squeeze the two blue handles together and pivot the guide assembly back to its closed position. Release the two blue handles. Make sure the assembly is securely latched in position.

Close the top cover.



General Troubleshooting

<i>Problem</i>	<i>Remedy</i>	<i>Page</i>
MACHINE		
Blank Screen		
No power.	Check that power cord is firmly connected and wall socket is switched ON.	1-1
Machine not switched ON.	Turn power switch (located on left side) ON.	2-1
Machine will not Operate		
Cover open.	Check that ALL covers are closed—check display for cover information.	
Feed trays/fold plates not located correctly.	Remove and relocate all feeders and fold plates. Make sure they are fully seated.	4-2
Insertion Problems		
Outer envelope contents do not enter the envelope correctly.	Check envelope troubleshooting table.	4-6
	Check that fold selected is correct for the material size you're using.	2-17 2-18
	If you're running heavy or light material, you may have to change the envelope stop adjustment.	2-19

4 • Reference

<i>Problem</i>	<i>Remedy</i>	<i>Page</i>
ENVELOPES		
Poor Envelope Feed		
Envelope side guides set incorrectly.	Set guides to envelope width and back off 1/2 turn.	2-6
Poor envelope quality.	Check that envelopes are not curled. Try a new box of envelopes. Make sure to fan stack <i>before</i> loading.	4-15 2-6
Envelopes loaded incorrectly.	Load envelopes flap side up with the flap feeding last.	2-6
Envelopes Fail to Open		
Envelopes loaded incorrectly.	The lead edge of the envelope should be under the front feed rollers. Load envelopes <i>flaps up</i> and <i>trailing</i> .	2-6
Poor envelope quality.	Check that envelopes are not stuck due to excessive dampness. Try a new box of envelopes.	4-15
Envelope Sealing Problems		
No sealing solution.	Refill sealer unit.	2-8
Seal mode not selected.	Check job setup. Activate sealing mode.	2-16

Problem	Remedy	Page
SHEETS		
Poor Sheet Feed		
Feeder not selected to feed.	Check job setup.	2-13
Sheet feeder side guides set incorrectly.	Set guides to sheet width and back off 1/4 turn.	2-4
Sheets loaded incorrectly.	Make sure to fan stack <i>before</i> loading.	2-4
Multiple Sheets Feed when One Is Expected		
Manual feed mode is selected.	Check job setup and manual feed lever position.	2-2
Sheets loaded incorrectly.	Make sure to fan stack <i>before</i> loading.	2-4
Address in Wrong Position in Envelope Window		
Address-bearing sheets incorrectly loaded.	Load sheets so that the address appears through the envelope window.	2-4
Folds incorrectly set.	Check job setup.	2-17 2-18
Poor Folding		
A fold <i>almost</i> corresponds with a perforation on the sheet, causing a box or third fold.	Adjust the fold sizes slightly to avoid this situation.	2-17 2-18

4 • Reference

<i>Problem</i>	<i>Remedy</i>	<i>Page</i>
INSERTS		
Poor Insert Feed		
Feeder not selected to feed.	Check job setup.	2-3, 2-20
Insert feeder side guides set incorrectly.	Set guides to insert width and back off 1/4 turn.	2-6
Insert feeder separator adjustments incorrect.	Make sure the two insert feeder adjustments (lever and separator shield) are set correctly for the type of insert you're running.	2-7
Inserts loaded incorrectly.	Make sure to fan stack <i>before</i> loading. Changing the orientation of the insert stack may help.	2-7
Insert feeder wedge used incorrectly.	Let the wedge slide down behind the insert stack to support it.	2-7
Inserts out of specification.	Check the material specifications in this guide.	4-15

<i>Problem</i>	<i>Remedy</i>	<i>Page</i>
DOUBLE DETECT		
Machine Stops for Doubles that Aren't There or Feeds Doubles without Stopping		
Double detect is not turned ON.	Check double detect status. Double detect icon  will appear alongside all items for which double detect is ON. Correct loading or job setup as necessary.	Chapter 2
Double detect is not correctly calibrated.	Run a trial piece whenever you load a new batch of material to recalibrate double detect. The new batch might have sheets that vary slightly in thickness from the old batch.	2-3

4 • Reference

Error Messages

Message	Action
CALL SERVICE	Power machine off and on. If message still displays, call for service.
CHECK /CLEAR FEEDER	The feeder indicated has failed to feed material. Remove material from the feed tray, reload and restart machine.
CHECK FEEDER	The feeder indicated is not located correctly. Remove tray and relocate. Also check loading of material in indicated feeder.
CHECK FOLD PLATE	Fold plate indicated is not located correctly. Remove fold plate and relocate.
CHECK INVERTER	Envelope inverter unit has not set to its correct position. Open inverter cover and check for any material. Close cover and restart.
CHECK LAST MAIL PIECE	Envelope has failed to open. Check that envelopes are loaded correctly. Reload envelopes and restart machine.
CLEAR FOLD PLATE	Material was detected inside the fold plate indicated on the display. Remove fold plate and check for any material. Install fold plate.
CLEAR INSERTION AREA	Material was detected in the inserting area. Open tinted plastic cover on left hand side of machine and remove any material. Close cover and restart.
CLEAR MOISTENER	Material was detected in the sealer brush area. Open tinted plastic cover on left hand side of machine and remove any material. Close cover and restart.
CLEAR SEALER	Material was detected in the sealer brush area. Open tinted plastic cover on left hand side of machine and remove any material. Close cover and restart.
CLOSE COVER	Cover indicated is not fully closed. Close indicated cover and restart.

<i>Message</i>	<i>Action</i>
CLOSE MAN ADV COVER	The manual advance knob door is not fully closed. Close door.
DEFLECTOR ERROR	The half fold function is not possible due to a fault. Remove fold plates and check for any material.
DOUBLE FEED	A double feed was detected from the feed tray indicated. Remove the material from the machine and restart. If double feeds persist, request another trial piece.
DOUBLE FEED CHECK STACKER	A double feed was detected from the feed tray indicated. Remove the double feed from the stacker. Restart machine.
FOLD PLATES NOT SET	The fold plates are not set to the correct position. Remove fold plates and check for any material. Install fold plates and restart.
MANUAL FEED TIMEOUT	Material was not detected as being fed from the feeder within a set time. In manual feed mode, you must feed the material within a set time. Press Start to restart the machine.
PAPER SHORT	The inserter detected that the material is too short in length. Check that actual material length matches the length displayed. If correct, request another trial piece.
PAPER SHORT CHECK STACKER	The inserter detected that the material used is too short in length. Check that actual material length matches the length displayed. If correct, request another trial piece.
SET LEVER	Manual feed lever in the incorrect position for the mode you're running. Move the manual feed lever to the correct position (left position: manual; right: automatic).
STREAM FEED	The machine detected two sheets fed together from the feed tray indicated. Remove material from the machine, reload and restart machine.

4 • Reference

<i>Message</i>	<i>Action</i>
STREAM FEED CHECK STACKER	The machine has detected two sheets fed together from the feed tray indicated. Remove the stream feed from the stacker. Reload machine and restart.
SYSTEM ERROR POWER DOWN	A fault was detected in the main software. Switch machine off and on and retry. If problem persists, call service.
TRAY EMPTY	Tray indicated has no material. Reload tray and press Start .

Material Specifications

Sheet Feeders

Minimum Sheet Size: 5 in. (127mm) width
5 in. (127mm) length

Maximum Sheet Size: 9 in. (229mm) width
16 in. (406mm) length

Paper Weights: 16 lb. (60g/m²) minimum (non OMR)
18 lb. (70g/m²) minimum (OMR)
32 lb. (120g/m²) maximum

Fold Configurations: Material length limits before folding

Single fold: 5 in. (127mm) - 12 in. (315mm)
C (letter fold): 6 in. (150mm) - 14 in. (356mm)
Z (accordion fold): 8 in. (201mm) - 14 in. (356mm)
Double fold: 12 in. (305mm) - 16 in. (406mm)

Double Document Detector Material range: 60g/m² (16 lb) Min
120g/m² (32 lb) Max

Feed Tray Capacity: Up to a maximum of 325 sheets of 20 lb.
bond (80g/m²)

Manual Feed Mode: In manual feed mode, the machine will process stapled sets of up to five sheets of 20 lb. bond (80g/m²) to a maximum total weight of 100 lbs. (400g/m²) per set.

Note: For manual feed applications, you may use *only* sheet feeder number 1, plus the insert feeder if required.

The maximum compressed thickness after folding *must not* exceed 0.078 inch (2mm).

We *do not* recommend the use of glossy/coated sheets.

4 • Reference

Fold Type and Overall Thickness Limits

The table below shows the maximum number of sheets that can be accumulated or collated for each fold type, based on different weights of paper.

Important! DO NOT program jobs that exceed these maximums or impose them by OMR code printing and/or OMR selective feed.

Number of sheets	Paper Weights in Pounds		
	16-20	20-26	26-32
1	C,Z,S,D	C,Z,S,D	C,Z,S,D
2	C,Z,S,D	C,Z,S,D	C,Z,S
3	C,Z,S,D	C,Z,S	C,Z,S
4	C,Z,S	C,Z,S	
5	C,Z,S		

Fold Types: C = C-Fold, Z = Z -Fold, S = Single Fold, D = Double Fold

Note: You can use the sheet limits above with one additional sheet from the supplementary feeder plus one insert, *only* if total mail piece contents do not exceed 0.078 in. (2mm) total compressed thickness

For single fold only, using 16 lb. to 20 lb. (60-75g/m²) paper only, you can place up to 10 items in an envelope. This maximum includes any additional sheet from the supplementary feeder and/or insert feeder.

The overall maximum compressed thickness of 0.078 in. (2mm) still applies.

Insert Feeder

Minimum Insert Size: 5 in. (127mm) width
3.25 in. (82mm) length

Maximum Insert Size: 9 in. (230mm) width
6 in. (152mm) length

Paper Weights: 20 lbs. (75g/m²) min. (non-folded cut sheet)
50 lbs. (180g/m²) max. (single sheet)
16 lbs. (60g/m²) min. (folded material)

And inserts of up to a maximum compressed thickness of 0.078 in. (2mm)

Pre-folded or single panel Inserts should be fed from the Insert Feeder.

Double Document Detector Material Range:

16 lbs. (60g/m²) minimum
32 lbs. (120g/m²) maximum

Feed Tray Capacity: Up to a maximum of 100 Inserts

Sealer

The machine can seal up to a maximum of 1200 envelopes between refills.

Stacker

The envelope stacker can accommodate up to 150 filled envelopes (depending on size and contents of the envelope).

Material Requirements

For best performance, use only materials approved by Pitney Bowes. Materials should be good quality and properly stored.

Recommended storage conditions: 18°C (65°F) to 25°C (77°F)
40% to 60% relative humidity

4 • Reference

Envelope Feeder

Minimum Envelope Size: 3.5 in. (88mm) depth
8.5 in. (220mm) width

Maximum Envelope Size: 6.5 in. (164mm) depth
9.5 in. (242mm) width

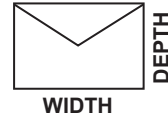

Envelope Weights: 17 lbs. (65g/m²) minimum
26 lbs. (100g/m²) maximum

Envelope Tray Capacity: Up to a maximum of 100 24 lb. (90g/m²) envelopes.

End Clearance: End clearance between insert and envelope is a minimum of 0.236 in. (6mm) at each side, that is, a minimum of 0.472 in (12mm) overall. Take this measurement with all documents placed in the envelope.

Depth Clearance: The insert must allow a minimum clearance of 0.118 in. (3mm) for unfolded documents, and 0.236 in. (6mm) for folded documents, below the flap crease after it is fully inserted into the envelope.

Envelope Flap and Throat Requirements:

See illustration below:

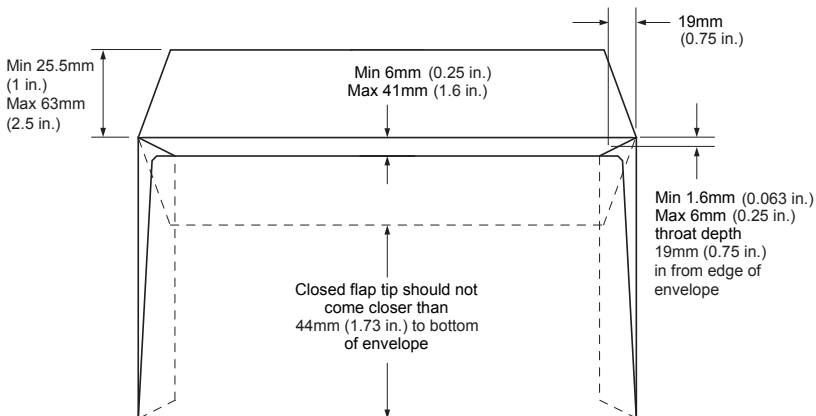

ALL SPECIFICATIONS ARE SUBJECT TO CHANGE WITHOUT NOTIFICATION AND ARE SUBJECT TO TEST

Machine Specifications

Physical Dimensions:

Length	30.4 in. (773mm)
Depth	22.3 in. (568mm)
Height	20.6 in. (525mm)
Weight	121 lbs. (55kg)

Noise Level (Running): 73dBA

Electrical: 120V, 60Hz, 6.0A

Speed:

Up to a maximum of 3,000 cycles per hour (depending on machine condition, operator skill, fold type and material quality)

Fold Modes: Single fold
C — Letter fold
Z — Accordion fold
Double fold

Compliance:



Pitney Bowes certifies that the inserting system complies with the requirements of the Low Voltage Directive 73/23/EEC and the EMC Directive 89/336/EEC. The product was tested in a typical configuration.



The inserting system is UL approved (US) and CUL approved (Canada).

Service

Service for your new folding/inserting machine is available throughout the United States and Canada.

Should you have questions about your machine, or require service or assistance with your particular application, please refer to the contact list at the front of this manual.

Pitney Bowes also offers a service maintenance agreement to keep your machine in top condition at nominal cost. For further information, call your local Pitney Bowes office. Also refer to the contact information located at the front of this manual.

4 • Reference

Jobs

Use the table below to keep a note of the jobs you've programmed into the system.

Job	Description
Default	
1	
2	
3	
4	
5	
6	
7	
8	
9	

JOBS

<i>Job</i>	<i>Description</i>
10	
11	
12	
13	
14	
15	
16	
17	
18	
19	
20	

Appendix A —Glossary

Term	Definitions
Accordion Fold	See <i>Z-Fold</i> .
Address-Bearing Document	The document on which the destination address appears. In <i>OMR</i> applications, the address-bearing document is often the control or primary document.
Accumulation	Mail piece contents assembled at a specific point in a paper transport. Also known as a “collation.”
Accumulator	A mechanical buffer in a paper transport where sheets, inserts or collated sets are merged.
Additional Set	A stack of sheets loaded into the folder/insertor that is to be combined with the prime sheet set and inserted into a mail piece. Any stack of material that is not the prime.
Additional Sheet	Any sheet except the prime sheet.
Batch	A specific number of pieces within a job run.
Beginning of Collation	A mark that indicates a sheet is the first sheet fed in a collation. This is used for error checking purposes only and provides additional verification that a collation is not split or combined with another collation into one package.
Benchmark	An <i>OMR</i> code indicating that more <i>OMR</i> codes are to follow. Also known as an <i>OMR</i> trigger. The benchmark must appear on every page of the document. It verifies that the scanner is working properly, and helps detect printing problems. Some inserter systems read <i>OMR</i> marks in reverse order, making the benchmark the last mark read.
Booklet	An insert with a bound or stapled edge.
Bound Edge First	An orientation in which the bound side of an item points toward the direction of feed (in other words, the bound edge is leading).
Brightness	The level of luminance of an operator display. Also see <i>Contrast</i> . The brightness and contrast of many operator displays are adjustable.
<u>B</u> usiness <u>R</u> eply <u>E</u> nvelope	A reply envelope that is sometimes postage paid. A very common insert, particularly in billing jobs.

Appendix A —Glossary

Term	Definitions
C-Fold	A type of <i>trifold</i> in which a sheet is folded in thirds with the top and bottom panels facing in the same direction. As seen from the edge, the fold looks like the letter “C.” Compare with <i>Z-Fold</i> .
Cancel	To stop or interrupt a process; to invalidate or undo a choice or option.
Card	A type of insert, heavier than a slip, thick enough to be mailed (≥ 0.007 inches, U.S.). Cards are not folded.
Checksum	A digit representing the sum of the digits in one instance of digital data; used to check whether errors have occurred during data transmission or storage.
Clear Deck	The process of cycling any material in the paper or envelope path out of the machine.
Clear Zone	A clear zone is a rectangular area on a sheet or insert reserved solely for the placement of <i>OMR</i> marks. To ensure reliable scanning, no other printed material, background color changes, or perforation lines can be present in the clear zone.
Collation	Two or more pieces of material assembled at a given point in the machine in a specific order. (Compare to <i>Accumulation</i> and <i>Set</i>).
Contrast	The difference in brightness between the light and dark areas of a display.
Control Document, Control Sheet	A document containing control codes in the form of optical marks (<i>OMR</i>) that tell an inserter system how to assemble a mail piece. The control codes assure that all inserts intended for a single addressee are properly assembled. Synonymous with “Prime Sheet.”
Control Panel	The main machine display and surrounding keys. An operator uses the control panel to check machine status, set up job runs and enter commands.
Cover	A machine part that protects the user from moving parts and provides access for user and service adjustments as well as jam clearance.

Appendix A —Glossary

Term	Definitions
DD	An abbreviation for <i>Double Detect</i> .
Depth Clearance (Envelope)	The required clearance between the depth of a mailing envelope and the depth of its contents (the assembled collation). Envelope depth is measured from the flap fold to the bottom of the envelope. If depth clearance is not adequate, the contents of the envelope will extend beyond the envelope flap fold, making the envelope difficult if not impossible to close and seal.
Document	One or more sheets assembled in a defined order intended for a single addressee. A three-page invoice where all the sheets come from the same tray is a document; a two-page letter consisting of pre-printed sheets, placed in separate trays and collated by the inserter, is also a document.
Default	An “as delivered” machine setting that stays in effect until changed by an operator or service personnel. Synonymous with “normal setting,” “factory setting,” and “standard setting.” The normal state of a machine or software option.
Double Detect	The process of sensing the feed of two or more sheets when only one should feed.
Double Fold	A fold style in which a sheet is folded in half, and in half again.
Downstream	Further along in the direction of feed. Example: A sealer is typically downstream from sheet and envelope feeders.
Drop Stacker	A type of stacker that uses gravity to stack finished mail pieces in an orderly fashion.
Duplex Printing	Printing on both sides of a sheet of paper.
EMI/EMC	Electromagnetic Interference / Electromagnetic Compliance.
End Clearance (Envelope)	For mechanical inserting, the required difference in width between the envelope and its contents. The clearance is necessary for reliable insertion. An end clearance specification must also account for the thickness of the inserted pack; the greater the thickness, the greater the required end clearance.

Appendix A —Glossary

Term	Definitions
End-of-Collation	A machine function that detects the presence or absence of an end-of-collation mark (see below). This mark signals an inserting system that a collation is complete.
End-of-Collation Mark	A mark designating a particular sheet or insert as the last page of a collation. The presence or absence of the mark can signal end-of-collation.
Envelope Depth	The dimension of an envelope measured from its flap fold to its opposite (bottom) edge.
Envelope Feeder	A device that feeds mailing envelopes into an inserting system.
Envelope Stop	An inserting machine station where a mailing envelope is parked, open and ready for insertion. The envelope stop position may be user adjustable.
Error	Any fault condition detected by a paper-handling system that requires remedial action on the part of the user or the system. Any abnormal condition that causes the system to stop while running, or prevents it from starting normally. Any stoppage of paper while running that is not recoverable by the machine. A paper jam. A fault.
ESD	Electrostatic Discharge. Can damage delicate electronic components if proper grounding procedures are not followed.
Face Down	Loading material with its front, printed side down.
Face Up	Loading material with its front, printed side up.
Failure	Any component failure that requires service adjustment, repair or replacement. An operator cannot correct a failure.
Fanning	Flipping through a stack of sheets, inserts or envelopes to help improve singulation. Also called "aeration." This loading process effectively separates material and enhances feed reliability.
Feeder	A device that separates one piece of material from a stack and drives it into a paper handling mechanism such as a folder or inserter for further processing.

Appendix A —Glossary

Term	Definitions
Flap Depth	The distance between the envelope flap fold and that part of the flap farthest opposite.
Flap First	An envelope orientation where the envelope feeds flap first. Flaps are normally closed but not sealed.
Flap Last	An envelope orientation where the envelope feeds flap last. When loaded, flaps are normally closed but not sealed.
Flap side down	An envelope orientation where the envelope feeds with the flap side facing down.
Flap side up	An envelope orientation where the envelope feeds with the flap side facing up.
Folder	A device that can fold material into a variety fold patterns, e.g., half fold, <i>C-Fold</i> (letter fold), <i>Z- (Accordion) Fold</i> .
Fold Panel	Refers to the areas of a sheet after folding. A half fold has two panels; a tri-fold (C- and Z-folds) has three. The panels are called top, middle and bottom.
Forward Flap Envelope	An envelope with the flap on the window side. Often used with advertising printed on the non-flap side.
Forward Order	Multi-page pieces in normal print order (1-n), where page one is in front of subsequent pages.
GSM	Grams per square meter. See <i>Paper Weight</i> .
Insert	Any piece of material placed into an envelope. More narrowly defined, a piece of material not folded by an inserter system (for example, a BRE, slip, or pre-folded sheet). The latter definition distinguishes between an insert (no fold) and a sheet (which is typically folded). As verb, the mechanical process of stuffing mail into an envelope.
Insert Feeder	A feeder dedicated to pieces that do not need folding, for example, a BRE or a pre-folded flyer.
Integrity	Refers to the accuracy of a collation. It means the document processing system has correctly assembled all the pieces of a collation intended for a single addressee.

Appendix A —Glossary

Term	Definitions
Item	One or more sheets or inserts from a single feeder that go into a mail piece.
Job	A quantity of mail pieces to be generated with a fixed setup arrangement.
Job Run	The process of creating mail defined by a particular setup instruction.
Job Settings	The collection of values that define how a mail piece is to be created by the hardware. A set of instructions within the machine used for assembling a single job or mail run.
Job Setup	The process of adjusting and programming an inserter system to handle a particular job.
Leading Edge	The first edge of a sheet, insert or envelope to enter a feed path.
Linked	<p>A method of using multiple feeders so that when one feeder runs out of material, the next “linked” feeder automatically starts feeding.</p> <p>This enables a higher volume of material to be processed before reloading is required. Linked feeders are also referred to as “cascading” feeders.</p> <p>Linking feeders can improve throughput.</p>
Mail Piece	An assembled article of mail, usually a letter, flat or card, with the correct contents.
Mail Piece Content	The set of items inside a mail piece. Content can consist of sheets, envelopes, cards, other inserts, or booklets. There can be multiple instances of each type of content.
Manual Advance Knob	A machine control that allows an operator to cycle a paper transport mechanism by hand. Normally used to clear jammed material from the machine’s transport deck. Also called a “crank.”
Manual Feeder	An operating mode that allows the user to feed one or more accumulated sheets through the machine. The sheets may be stapled or not stapled.
Mark Absent	A condition in which the absence of an OMR mark triggers a machine function. When the mark is present, no function is triggered.

Appendix A — Glossary

Term	Definitions
Mark Present	A condition in which the presence of an OMR mark triggers a machine function. When the mark is absent, no function is triggered.
Material	A broad term referring to any type of paper in any form that a paper handling device can process. Material includes sheets, cards, slips, envelopes, pre-folded and pre-collated sets and booklets.
Maximum Number of sheets	The maximum number of sheets an inserter system can handle reliably. Some inserter systems limit user selections so that the maximum sheet value can't be exceeded.
Navigate	To move through a menu structure, typically hierarchical, in order to locate and select appropriate setup options or machine commands.
Nesting	A term that describes an insert or inserts placed inside a folded sheet before the sheet is inserted into an envelope.
OMR Marks	Control codes in the form of printed dash lines on sheets and inserts that tell an inserting system how to process and assemble a mail piece. Also see <i>Scan Window</i> .
Open Edge First	Describes the orientation of an insert in a feeder where the open edge feeds first.
Open Edge last	For pre-folded inserts, describes the orientation of an insert in an insert feeder where the closed edge feeds first. Typically used when a tabbed or non-tabbed pre-folded sheet is used as an insert. Also see <i>Tabbed Insert</i> .
Optical Mark Reader	A scanner capable of seeing control marks on a printed page.
Outer Envelope	The envelope that contains the completed mail piece, as distinguished from business reply envelopes (BREs) which are considered inserts.
Outsort	The process of diverting or separating an unfinished mail piece from the paper handling stream. Outsorted pieces usually require special handling: they may be oversized; the page count may be more than the system can handle; or they may be error pieces.

Appendix A —Glossary

Term	Definitions
Page Count	The number of pages fed per collation.
Paper Path	In a paper transport system, the path followed by material as it moves through the machine.
Paper/Sheet Length	The dimension of a sheet or insert as measured in the direction of feed.
Paper/Sheet Width	The dimension of a sheet, insert or envelope as measured at right angle with respect to paper length.
Paper Weight	A measure of the “substance” or heft of paper. In the United States this measurement is expressed as the weight of 500 master sheets of paper. A master sheet of bond paper is 17 x 22 inches. Typical weights are 20 and 24 pounds. A master sheet of offset paper is 38 x 25 inches. A typical weight is 60 pounds. For the international ISO standard, paper weight is the weight of a single, one square meter sheet measured in grams. See <i>GSM</i> .
Parity	A security feature of <i>OMR</i> marks, that, when printed, always makes the number of marks total an odd or even number.
Piece	Term applied to either a completed mail piece or a single sheet of material.
Power Stacker	A motor-driven belt stacker, usually horizontal, on to which finished mail pieces are deposited in an orderly, shingled stream.
Pre-Folded Insert	An insert that’s been folded before loading into the machine.
Primary Feeder	The feeder containing the prime sheet set. In <i>OMR</i> , the prime sheet set has the control marks on it.
Primary Sheet Set	A group of sheets that includes the prime or control sheet. See Prime Sheet below.
Prime Sheet	The first page of a prime sheet set. This sheet normally bears the address and the control code (<i>OMR</i>) marks that tell an inserting system how to process a mail piece. It is closest to the part of the envelope that has the window, or the face of a windowless envelope.

Appendix A —Glossary

Term	Definitions
Power-On Reset	Re-initializing a device by turning the power off, then on.
Run	A single instance of a job.
Scan Window	A designated area on a sheet or insert reserved solely for OMR marks. Sometimes referred to as the “scan zone.” The start scan mark is located in this zone and begins the scanning process. There must be no printed material in the scan window other than the OMR marks.
Scanner	A device that reads OMR dash marks.
Sealer	A module in an inserting system that moistens an envelope flap, closes and seals it.
Sealing	The process of moistening an envelope flap, closing it and applying pressure to seal it.
Select	With respect to the operator interface (control panel), the process of making a choice.
Select Feed Marks	Marks on the prime or control document (or first sheet in the control document) that indicate which downstream feeders should feed. A downstream selectable feeder will feed if the mark is present on all pages of the control document.
Selective feed	A function that instructs the inserter system to select material from specified feeders. This is controlled by select feed OMR marks.
Set	One or more items assembled together.
Sheet	A paper item, folded or unfolded, taken from a stack of material.
Sheet Feeder	A feeder tray that accepts sheets only. The sheets are loaded one on top of another.
Sheet Set	A collection of sheets or pages, usually defined by the user. A sheet set is made up of sheets only (inserts are not sheets).
Shingle	To align sheets or inserts such that they overlap, but are not directly above one another (like shingles on a roof). Shingling is required for reliable feeding of some material types.
Single sheet	One sheet of paper.

Appendix A —Glossary

Term	Definitions
Slip	A type of insert, generally a single-thickness document that fits into an envelope without folding.
Stacker	An output device that stacks finished mail pieces in an orderly fashion. Gravity stackers stack materially vertically. Power stackers usually stack material in a horizontal, shingled stream.
Tabbed Insert	A pre-folded insert whose open edge is closed by a sticker or piece of tape. The material used to secure the closure is called a “tab.”
Timing Mark	An <i>OMR</i> mark used to reset the timing between marks. In some inserter systems, the timing mark is required to read a long control code sequence reliably.
Top Feed	The process of feeding material from the top of a stack. This is a more common method than <i>bottom feed</i> .
Top First	A feed orientation in which the address or top line of printed material feeds first.
Top Scanning	Scanning from a reader located above the paper path; reading marks printed on the top sheet.
Trailing Edge	The last edge of a piece of material to enter or leave a paper handling system. Contrast with <i>Leading Edge</i> .
Tray	A removable part of a feeder that holds material. Stackers can also have trays. Feed trays are usually equipped with adjustable side guides that confine the material to be fed.
Trial Piece	An unsealed mail piece sent through an inserting system to check that machine setup is correct and mail piece integrity is good.
Uncollated Sheet	Refers to a stack of sheets in which all pages are identical. As an example, all sheets may be page 1 sheets. Contrast with collated sheets, where the printed content of each sheet is different. For example, a collated set may contain page 1, page 2, page 3, and so on.

Appendix A —Glossary

Term	Definitions
User Interface	The controls and display that allow a user to interact with a machine, computer or software application.
Wedge	Sometimes referred to as a material prop or sled, a wedge raises the feed angle of a stack of material. It's designed to help shingled stacks of material feed reliably. The position of the wedge is operator-adjustable.
Tri-Fold	A sheet folded in thirds. See <i>C-Fold</i> and <i>Z-Fold</i> .
Window	A cut-out portion of an envelope that allows the address to show through. The window may be open (not recommended for mechanical inserting systems) or closed with clear glassine or polystyrene.
Wrap-Around Sequencing	A numbering system that starts on the first page of a print run, which is sequential throughout the run. The marks can be set to check for either ascending or descending sequence. If one of these is chosen, then the collation sets must occur in the correct sequence or the machine will stop mail processing and declare an error. This feature provides an additional level of document processing integrity.
Z-Fold	A fold type where a sheet is folded in thirds with the top and bottom panels facing opposite directions. Also known as an accordion fold. The fold looks like the letter "Z" when viewed from the edge.
ZIP	An acronym for Zone Improvement Program. A Zone Improvement Plan (ZIP) Code is the numerical code assigned by the US Postal Service to designate a local area or entity for the delivery of mail. ZIP Codes may consist of 5, 7, 9, or 11 digits, and may refer to a street section, a collection of streets, an establishment, a structure, or a group of post office boxes.

Appendix A —Glossary

A

- AC Adapter
 - Safe Use of with Stacker 1-2
- Accordion Fold
 - Definition A-1
- Accumulation
 - Definition A-1
 - Setting up Multiple Feed 2-12
- AC Power, Connect 2-1
- Additional
 - Set, Definition A-1
 - Sheet, Definition A-1
- Address
 - in Wrong Position 4-7
 - Too High, Correcting 2-21
 - Too Low, Correcting 2-21
- Address-Bearing Document
 - Definition A-1
- Advance Knob
 - Using the 4-1
- Assistance, Getting v
- Auto Batch
 - OMR Mark 3-7

B

- Basic
 - OMR (Optical Mark Recognition) 3-2
 - Scanning Functions 3-12
- Batch
 - Counter, Selecting the 2-19
 - Definition A-1
- Beginning-of-Collation (BOC)
 - Definition A-1
 - OMR Mark 3-6
- Benchmark (OMR) 3-6
 - Definition A-1
- Booklet
 - Definition A-1
- Bound Edge First
 - Definition A-1
- Brightness
 - Definition A-1
- Business Reply Envelope
 - Definition A-1

C

- C-Fold
 - Definition A-2
- Cancel
 - Definition A-2
- Card
 - Definition A-2
- Carriage Assembly
 - Accessing the 4-3
- Change
 - a Job 2-22
 - Control 1-8
- Checksum
 - Definition A-2
- Clear
 - Deck Control 1-8
 - Definition A-2
 - Material 4-1
 - Zone, Definition A-2
- Collation
 - Definition A-2
- Compliance, Agency 4-17
- Confirming Job Setup 2-20
- Contrast
 - Definition A-2
- Control Document, Control Sheet
 - Definition A-2
- Control Panel 1-8
 - Change +/- 1-8
 - Clear Deck 1-8
 - Default 1-8
 - Definition A-2
 - Delete 1-8
 - Job 1-8
 - Location and Description 1-7
 - Prev/Next 1-8
 - Reset Counter 1-8
 - Setup 1-8
 - Start 1-8
 - Stop 1-8
 - Trial Piece 1-8
- Controls and Features
 - Display/Control Panel 1-7
 - Drop Stacker or Output Device 1-7
 - Envelope Feeder 1-7
 - Envelope Inverter 1-7

Index

Controls and Features (*Continued*)

- Fold Plates 1 and 2 1-7
- Insert Feeder 1-7
- Manual Advance Knob 1-7
- Measuring Scale 1-7
- Sealer Bottle 1-7
- Sheet Feeder 1 1-5
- Sheet Feeder 2 1-5

Cover

- Definition A-2

Customer Service, Calling v

D

DD (Double Document)

- Definition A-3

Default

- Control 1-8
- Definition A-3

Delete

- A Job 2-22
- Control 1-8

Depth

- Clearance (Envelope) 4-16
- Definition A-3

Dimensions, Machine 4-17

Display

- Blank Screen 4-5
- Language, Changing the 4-1
- Location and Description 1-7
- Symbols 1-9

Document

- Definition A-3

Double Detect

- Definition A-3
- Material Range 4-13
- Problems with
“False Doubles” or Double
Feeds 4-9

Double Fold

- Definition A-3

Downstream

- Definition A-3

Drop Stacker

- Definition A-3

Duplex Printing

- Definition A-3

E

Electrical Specifications 4-17

EMI/EMC

- Definition A-3

End-of-Collation (EOC)

- Definition A-4
- Mark, Definition A-4
- OMR Mark 3-6

End Clearance (Envelope) 4-16

- Definition A-3

Enhanced OMR 3-2

Envelope

- Depth, Definition A-4
- Depth, Setting 2-18
- Depth Clearance 4-16
- End Clearance 4-16
- Exit Area, Accessing the 4-3
- Fails to Open 4-6
- Feeder
 - Area, Accessing the 4-3
 - Definition A-4
 - Location and Description 1-7
 - Setting the 2-6
- Feed is Poor 4-6

Flap and Throat Requirements 4-16

- Insert/Sealing Area, Accessing
the 4-4

Inverter

- Location and Description 1-7

Sealing Problems 4-6

Size Specification 4-16

Stop

- Definition A-4

- Setting the 2-19

Tray Capacity 4-16

Weight Specification 4-16

Error

- Definition A-4

Messages 4-10

Recovery for Accumulation Jobs 3-18

Recovery for Empty Feeders 3-18

Recovery for OMR Jobs 3-18

Error Messages

- Call Service 4-10
- Check/Clear Feeder 4-10
- Check Feeder 4-10
- Check Fold Plate 4-10
- Check Inverter 4-10
- Check Last Mail Piece 4-10
- Clear Fold Plate 4-10
- Clear Insertion Area 4-10
- Clear Moistener 4-10
- Clear Sealer 4-10
- Close Cover 4-10
- Close Man Adv Cover 4-11
- Deflector Error 4-11
- Double Feed 4-11
- Double Feed Check Stacker 4-11
- Fold Plates not Set 4-11
- Manual Feed Timeout 4-11
- Paper Short Check Stacker 4-11
- Paper Short Timeout 4-11
- Set Lever 4-11
- Stream Feed 4-11
- Stream Feed Check Stacker 4-12
- System Error Power Down 4-12
- Tray Empty 4-12

ESD

- Definition

F

Face

- Down, Definition A-4
- Up, Definition A-4

Failure

- Definition A-4

Fanning

- Definition A-4

FAQs v

Feed

- Manual, Notes About 2-14
- Mode, Manual 4-13
- Tray Capacity 4-13

Feeder

- Definition A-4

Flap

- Depth, Definition A-5
- First, Definition A-5
- Last, Definition A-5
- Side Down, Definition A-5
- Side Up, Definition A-5

Fold

- A, Setting Size of 2-17
- B, Selecting Size of 2-18
- Configurations 4-13
- Making Minor Changes to 2-21
- Only Mode 2-15
- Panel, Definition A-5
- Plates, Removing the 4-2
- Plates 1 and 2, Location and Description 1-7
- Poor Quality 4-7
- Type, Setting the 2-11,3-13
- Type and Thickness Limits 4-14

Folder

- Definition A-5

Forward

- Flap Envelope, Definition A-5
- Order, Definition A-5

H

Hand Wheel

- Definition A-6

Help, Getting iii

I

Insert

- Definition A-5
- Feeder
 - Definition A-5
 - Location, Description 1-7
 - Setting the 2-6,2-15
- Feed Poor 4-8
- Size Specification 4-15
- Tray, Removing the 4-2

Inserter

- Will Not Operate 4-5

Insertion

- Problems 4-5

Integrity

Index

Definition A-5
Item
Definition A-6

J

Job
Changing an Existing 2-22
Control 1-8
Creating a New 2-9
Definition A-6
Deleting a 2-22
Listing, Operator Record 5-1
Number, Choosing A 3-10
Number, Choosing a New 2-10
Programming 2-9
Run, Definition A-6
Selecting a 2-2
Settings
Making Minor Changes to 2-21
Settings, Definition A-6
Setup, Confirming 2-20
Setup, Definition A-6
Testing a 2-21

L

Language
Display, Changing the 4-1
Leading Edge
Definition A-6
Linked Feeders
Definition A-6
Linking Feeders 2-13

M

Machine
Configurations 1-3
Features 1-3
Identification (Controls, Indicators
and Features) 1-5
Speed 1-4
Machine Specifications 4-17
Mail Piece
Content, Definition A-6
Definition A-6

Manual Advance Knob
Location and Description 1-7
Using the 4-1
Manual Feeder
Definition A-6
Mark
Absent, Definition A-6
Present, Definition A-7
Material
Clearing from the Transport 4-1
Definition A-7
Requirements, General 4-15
Specifications 4-13
Envelope
Size 4-16
Maximum Number of Sheets
Definition A-7
Measuring Scale
Location and Description 1-7
Messages
Error 4-10
Mode
Fold-Only 2-15
Insertion 2-15
Setting the Machine 2-15

N

Navigate
Definition A-7
Nesting
Definition A-7
Noise Level 4-17

O

Offset OMR Positions 3-2
OMR
Auto Batch 3-7
Availability 3-1
Beginning-of-Collation (BOC) 3-6
Benchmark 3-6
End-of-Collation (EOC) 3-6
Error Messages 3-18
Functional Description 1-4,3-1
Functions, Selecting 3-11
Levels of 3-2

- OMR (*Continued*)
 - Mark
 - Definition 1-4
 - Grouping 3-8
 - Marks
 - Available 3-6
 - Definition A-7
 - Position of 3-2
 - Typical, Illustration of 3-1
 - Offset Mark Positions 3-2
 - Overview of 3-1
 - Parity 3-6
 - Positions
 - Offset 3-5
 - Standard 3-4
 - Programming a Job with 3-10
 - Retiming Mark 3-7
 - Safety Mark 3-6
 - Scanner Adjustment 3-16
 - Select Feed (SF1, SF2) 3-7
 - Setting the Mode 2-10
 - Specifications 3-3
 - Standard Mark Positions 3-2
 - Troubleshooting 3-18
 - Wrap Around Sequence (WAS1, WAS2, WAS3) 3-7
- Open
 - Edge First, Definition A-7
 - Edge Last, Definition A-7
- Optical Mark Reader
 - Definition A-7
- Optical Mark Recognition. *See* OMR
- Outer Envelope
 - Definition A-7
- Outsort
 - Definition A-7
- P**
 - Page Count
 - Definition A-8
 - Paper
 - Length, Selecting the 2-17
 - Path, Definition A-8
 - Sheet Length, Definition A-8
 - Sheet Width, Definition A-8
 - Weight, Definition A-8
- Paper (*Continued*)
 - Weight Specification
 - for Inserts 4-15
 - for Sheets 4-13
 - Parity
 - Definition A-8
 - OMR Mark 3-6
 - Phone Customer Service iii
 - Physical Dimensions 4-17
 - Piece
 - Definition A-8
 - Power
 - Connect 2-1
 - On Reset, Definition A-9
 - Stacker, Definition A-8
 - Pre-Folded Insert
 - Definition A-8
 - Prev/Next
 - Control 1-8
 - Primary
 - Feeder, Definition A-8
 - Sheet Set, Definition A-8
 - Prime Sheet
 - Definition A-8
 - Program
 - an OMR Job 3-10
 - Job Records (Operator) 5-1
- R**
 - Removal and Replacement
 - Fold Plates 4-2
 - Insert Tray 4-2
 - Sheet Feeder Trays 4-2
 - Reset Counter Control 1-8
 - Retiming Mark
 - OMR Mark 3-7
 - Run
 - Definition A-9

Index

S

Safety

- Mark (OMR) 3-6
- Notes 1-1,1-2

Scanner

- Definition A-9

Scanning Functions

- OMR, Basic 3-12
- Select Feed/Autobatch 3-12
- Sequence 3-12

Scan Window

- Definition A-9

Screen is Blank 4-5

Sealer

- Bottle
 - Location and Description 1-7
- Capacity 4-15
- Definition A-9
- Filling the 2-8
- Turning ON or OFF 2-16

Sealing

- Definition A-9

Select

- Definition A-9
- Feed Marks, Definition A-9

Select Feed (SF1, SF2)

- OMR Mark 3-7

Select Feed/Autobatch Scanning Functions 3-12

Selective feed

- Definition A-9

Select Job 2-2

Sequence Scanning Functions 3-12

Service 4-17

Set

- Definition A-9

Setup

- Accumulation Function, Setting 2-12
- Adjusting the Stacker 2-8
- Adjustment of OMR Scanner 3-16
- Batch Counter, Selecting 2-19
- C-Fold and Double Fold Jobs with OMR Scanning 3-8
- Changing an Existing Job 2-22

Setup (Continued)

- Choosing the New Job Number 2-10

- Confirming the Job 2-20

- Control 1-8

- Creating a New Job 2-9

- Deleting a Job 2-22

- Envelope Depth, Setting 2-18

- Envelope Feeder, Setting 2-6

- Envelope Stop, Setting 2-19

- First/Main Sheet Feeder, Setting 2-13

- Fold A, Selecting Size of 2-17

- Fold B, Setting Size of 2-18

- Fold Type 2-11

- Insert Feeder, Setting 2-6, 2-15

- Linking Feeders 2-13

- Machine Mode, Selecting 2-15

- Main (Scanning) Sheet Feeder, Setting 3-14

- Mode, Entering 2-9

- Notes on Manual Feed 2-14

- OMR 2-10

- Paper Length, Selecting the 2-17

- Run a Trial Piece 2-3

- Sealer, Filling 2-8

- Sealer, Turning ON or OFF 2-16

- Second/Supplementary Sheet Feeder, Setting 2-14

- Select/Supplementary Feeders, Setting 3-15

- Sheet Feeders, Setting 2-4

- Testing the Job 2-21

- Z-Fold and Single Fold Jobs with OMR Scanning 3-9

Sheet

- Definition A-9

- Feed Area, Accessing the 4-4
- Feeder

- Definition A-9

- First, Setting the 2-13

- Location, Description 1-5

- Second, Setting the 2-14

- Second Location Description 1-5

- Setting the 2-4

- Sheet Feeder (*Continued*)
 - Setting the Main Scanning 3-14
 - Trays, Removing the 4-2
 - Feed Poor 4-7
 - Multiple Feeds 4-7
 - Set, Definition A-9
 - Size Specification 4-13
 - Shingle
 - Definition A-9
 - Single sheet
 - Definition A-9
 - Slip
 - Definition A-10
 - Specifications
 - Machine
 - Compliance 4-17
 - Dimensions 4-17
 - Electrical 4-17
 - Fold Modes 4-17
 - Noise Level 4-17
 - Speed 4-17
 - Material 4-13
 - Double Detect Material Range 4-13
 - Envelope
 - Depth Clearance 4-16
 - End Clearance 4-16
 - Flap and Throat Requirements 4-16
 - Tray Capacity 4-16
 - Weights 4-16
 - Feed Tray Capacity 4-13
 - Fold Configurations 4-13
 - Fold Type and Thickness Limits 4-14
 - Insert Feeder
 - Double Detect Material Range 4-15
 - Feed Tray Capacity 4-15
 - Insert Size 4-15
 - Paper Weights 4-15
 - Manual Feed Mode 4-13
 - Paper Weights 4-13
 - Sheet Size 4-13
 - OMR 3-3
 - Speed
 - Machine 1-4
 - Stacker
 - Adjusting 2-8
 - Definition A-10
 - Location and Description 1-7
 - Using AC Adapter with 1-2
 - Standard OMR Positions 3-2
 - Start
 - Control 1-8
 - Operation 2-3
 - Stop Control 1-8
 - Symbols, Display 1-9
- ## T
- Tabbed Insert
 - Definition A-10
 - Test a Job 2-21
 - Timing Mark
 - Definition A-10
 - Top
 - Feed, Definition A-10
 - First, Definition A-10
 - Scanning, Definition A-10
 - Trailing Edge
 - Definition A-10
 - Tray
 - Capacity, Envelope 4-16
 - Definition A-10
 - Feed, Capacity 4-13
 - Feed Capacity for Inserts 4-15
 - Insert, Removing the 4-2
 - Tri-Fold
 - Definition A-11
 - Trial Piece
 - Control 1-8
 - Definition A-10
 - Running a 2-3
 - Troubleshooting
 - Address in Wrong Position in Envelope Window 4-7
 - Blank Screen 4-5
 - Double Detect Problems 4-9
 - Envelope Sealing Problems 4-6

Index

Troubleshooting (*Continued*)

- Envelopes Fail to Open 4-6
- Error Recovery
 - for Accumulation Jobs 3-18
 - for Empty Feeders 3-18
- Insertion Problems 4-5
- Machine will not Operate 4-5
- Multiple Sheets Feed when One Is Expected 4-7
- OMR 3-18
- Poor Envelope Feed 4-6
- Poor Folding 4-7
- Poor Insert Feed 4-8
- Poor Sheet Feed 4-7
- Table 4-5

U

- Uncollated Sheet
 - Definition A-10
- User Interface
 - Definition A-11

W

- Wedge
 - Definition A-11
- Window
 - Definition A-11
- Wrap-Around Sequencing
 - Definition A-11
- Wrap Around Sequence (WAS1, WAS2, WAS3)
 - OMR Mark 3-7

Z

- Z-Fold
 - Definition A-11
- ZIP
 - Definition A-11



Engineering the flow of communication™

1 Elmcroft Rd.
Stamford, Connecticut 06926-0700
www.pitneybowes.com

5500 Explorer Drive
Mississauga, Ontario L4W5C7
www.pitneybowes.ca

PB Form SV61656 Rev B (5/06)

Printed in the USA or Canada



Printed on recyclable paper



* S V 6 1 6 5 6 R E V A *