



Shipping & Mailing
Inserter

Relay™ 1000

Document Inserting System

Operator Guide

US International English Edition

SV63176 Rev. B

February 1, 2016



Statement of FCC Compliance

This equipment has been tested and found to comply with the limits for a Class A digital device, pursuant to part 15 of the FCC rules. These limits are designed to provide reasonable protection against interference when the equipment is operated in a commercial environment. This equipment generates, uses, and can radiate radio frequency energy and, if not installed and used in accordance with the instruction manual, may cause interference to radio communications. Operation of this equipment in a residential area is likely to cause interference, in which case the user will be required to correct the interference at his own expense.

CAUTION: Changes or modifications to this equipment not expressly approved by the party responsible for compliance (Pitney Bowes) could void the user's authority to operate the equipment.



It is certified that the equipment complies with all applicable Directives of the European Union. For a formal Declaration of Conformity, please contact Pitney Bowes.

SV63176 RevB ©2005, 2016 Pitney Bowes Inc.

All rights reserved. This book may not be reproduced in whole or in part in any fashion or stored in a retrieval system of any type or transmitted by any means, electronically or mechanically, without the express, written permission of Pitney Bowes. We have made every reasonable effort to ensure the accuracy and usefulness of this manual; however, we cannot assume responsibility for errors or omissions or liability for the misuse or misapplication of our products.

Due to our continuing program of product improvement, equipment and material specifications as well as performance features are subject to change without notice. E-Z Seal is a registered trademark of Pitney Bowes.

Safety Information	iii
--------------------------	-----

Chapter 1: System Overview

About Your System	1-3
System Configurations	1-3
Component Identification	1-4
About Sleep Mode	1-7
Advanced Menu Options	1-8
Reset Counter	1-8
Change Paper Size (Not on All Configurations)	1-8
Move the Address in the Window	1-9
Sheet Double Detect On/Off	1-9
Insert Double Detect On/Off	1-10
Safe Seal On/Off	1-10

Chapter 2: System Overview

Preparing and Loading	2-3
Connecting Power and Turning On	2-3
Fill the Moistener	2-4
Loading the Sheet Feeders (Feeders A1 and A2)	2-5
Loading the Envelope Feeder (Feeder B)	2-6
Remove/Install the Stacker	2-8

Chapter 3: Run a Job

Run a Job	3-3
All Models	3-3
Models with an Insert Feeder	3-3
Models with an Optional Second Sheet Feeder	3-4
Models with an Insert Feeder and Second Sheet Feeder	3-5
Manual Feeder M	3-16

Chapter 4: Clear Material

Clear Material Jams	4-3
---------------------------	-----

Table of Contents

Chapter 5: Troubleshooting and Error Messages

General Troubleshooting	5-3
Error Messages	5-5

Chapter 6: Specifications

Specifications - U.S.	6-3
Material Specifications - U.S.	6-3
System Specifications - U.S.	6-5
Specifications - International	6-6
Material Specifications - International	6-6
System Specifications - International	6-8

Safety Information

- Read all instructions before you attempt to operate the system.
- Use this equipment only for its intended purpose.
- Place the system close to an easily accessible wall outlet.
- Place the system in an accessible location to allow for proper venting of the equipment and to facilitate servicing.
- Use the AC power cord included with this device.
- Plug the AC power cord directly into a properly grounded wall outlet located near the equipment and easily accessible. Failure to properly ground the machine can result in severe personal injury and/or fire.
- The AC /power cord is the primary means to disconnect this device from the AC supply.
- DO NOT use a wall outlet controlled by a wall switch or one that is shared with other equipment.
- DO NOT use an adapter plug on the power cord or wall outlet.
- DO NOT remove the ground pin from the power cord.
- DO NOT route the AC power cord over sharp edges or trapped between furniture.
- DO NOT route the power cord over sharp edges or trap it between pieces of furniture. Make sure there is no strain on the power cord.
- If the unit becomes damaged, unplug it from the wall.
- Keep fingers, long hair, jewelry and loose clothing away from moving parts at all times.
- Avoid touching moving parts or materials while the machine is in use. Before clearing a jam, be sure machine mechanisms come to a complete stop.
- Remove jammed material gently and carefully.
- DO NOT remove covers. Covers enclose hazardous parts that should only be accessed by properly trained service personnel.
- DO NOT place lighted candles, cigarettes, cigars, etc., on the system.
- To prevent overheating, do not cover vent openings.
- Use only approved supplies.
- Improper storage and use of aerosol dusters or flammable aerosol dusters can cause an explosive-like condition that could result in personal injury and/or property damage.
- Never use aerosol dusters labeled flammable and always read instructions and safety precautions on the duster container label.

Safety

- Operation of this equipment without periodic maintenance will inhibit optimum operating performance and could cause the equipment to malfunction.
- Always follow specific occupational safety and health standards for your workplace.
- To reduce the risk of fire or electrical shock, DO NOT attempt to remove covers or disassemble the control panel or its base. The cabinet encloses hazardous parts.
- Immediately report to service any damaged or non-functioning components that renders the unit unsafe.
- Contact your system supplier for the following:
 - Supplies
 - Material Safety Data Sheets
 - If you should damage the unit
 - Required maintenance service schedule



CAUTION! Before you relocate a Relay 1000 with an optional second Sheet Feeder A2 installed:

1. Unplug the power cord from the wall outlet.
2. Remove the Relay 1000 from the second Sheet Feeder — as you lift it clear, make sure it fully disengages from the second Sheet Feeder. Obtain help if necessary.

1 • System Overview

Contents

About Your System	1-3
System Configurations	1-3
Component Identification	1-4
Advanced Menu Options	1-8
Reset Counter	1-8
Change Paper Size	1-8
Move the Address in the Window	1-9
Sheet Double Detect On/Off	1-9
Insert Double Detect On/Off	1-10
Safe Seal On/Off	1-10

This page is intentionally blank.

About Your System

Your Relay 1000 is a compact folding and inserting system designed to speed the process of mail creation. The system has a minimal number of user adjustments and an intuitive, easy-to-use control panel.

System Configurations

There are four configurations of the Relay 1000, as shown in the diagrams below. All four configurations come standard with a sheet feeder and an envelope feeder. All four can accept an optional second sheet feeder.

Configuration 1

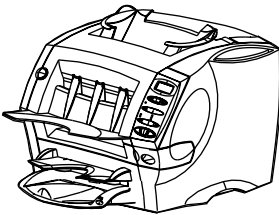

- One Sheet Feeder
- One Envelope Feeder

Configuration 2

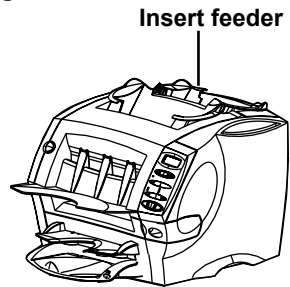

- One Sheet Feeder
- One Envelope Feeder
- One Insert Feeder

Configuration 3

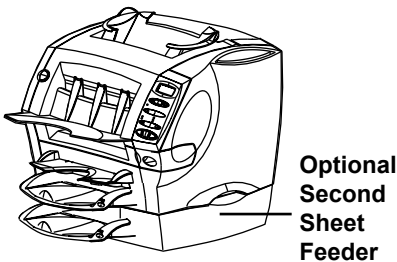

- One Sheet Feeder
- One Envelope Feeder
- Optional Second Sheet Feeder

Configuration 4

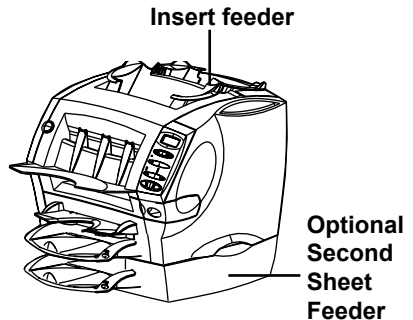

- One Sheet Feeder
- One Envelope Feeder
- One Insert Feeder
- Optional Second Sheet Feeder

1 • System Overview

Component Identification

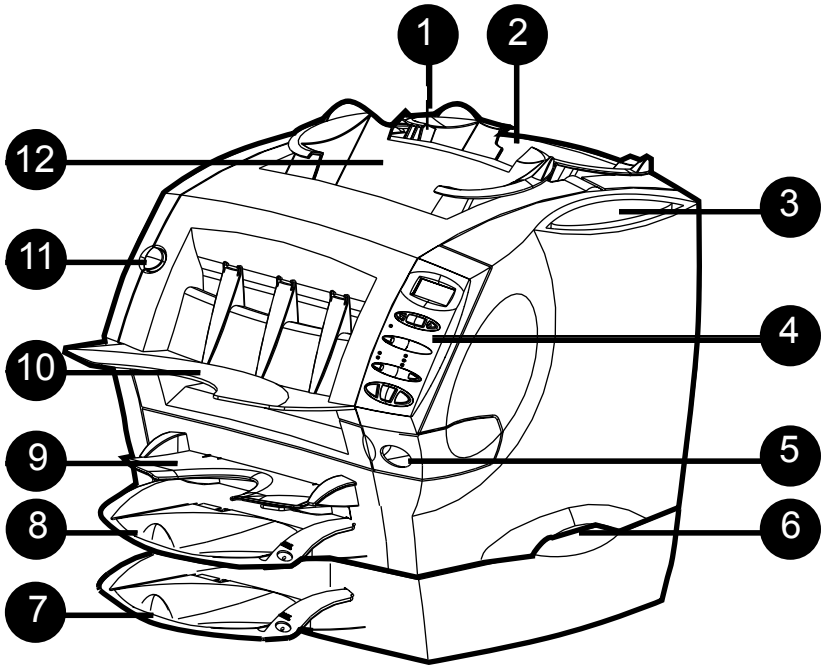

- 1 Insert Cover E Release Button (Blue Button Marked E)**
The display prompts you to press this button to open this cover when you need to remove jammed material
- 2 Insert Feeder (not on all models)**
Use this feeder to add inserts to your envelope. Material fed from this feeder cannot be folded by the system. However, this feeder is especially suited to pre-folded or thicker inserts.
- 3 Slot for Operator Guide**
Store the Operator Guide in the slot provided so that it is readily available when you need it.
- 4 Control Panel**
This is where you enter commands and where the system informs you of its status. See the *Systems Controls* section of this chapter for a functional description of each button.

5

Moistener Tank

This tank contains E-Z Seal® solution or water to moisten and seal envelope flaps. It slides out to the right for refilling and has an oval level indicator window at the front that makes fluid level checks quick and easy.

6

Lifting Handles (One Each Side)

Always lift the Relay 1000 using the side handles. DO NOT lift the system by any of the feeders or the stacker.

7

Second Sheet Feeder A2 (Optional)

You can add this feeder to the system to enable folding and inserting of a second sheet into the envelope. It functions in exactly the same way as the standard sheet feeder A1.

IMPORTANT! When you use both sheet feeders A1 and A2 together, always load the address bearing sheet into sheet feeder A2. If you fail to do this, the address won't show in the envelope window. Always load sheets into feeder A2 face down and with the bottom edge of the sheet going first into the system.

8

Standard Sheet Feeder A1

This feeder enables folding and inserting of a sheet into the envelope. Always load sheets into this feeder face down and bottom edge first.

9

Manual Feeder M

Use this feeder to manually feed stapled sets of up to three sheets each. The system waits for you to feed each set by hand into this feeder before it folds and inserts the set automatically. Always feed sheets into this feeder face down, bottom edge first.

10

Stacker

The system delivers finished pieces to this area.

11

Front Cover Release Button (Blue Button Marked "D")

The display prompts you to press this button to release the front cover if you need to remove jammed material.

12

Envelope Feeder B

This feeder sends envelopes into the inserting area where they are filled with sheets or inserts from other feeders.

1 • System Overview

System Controls

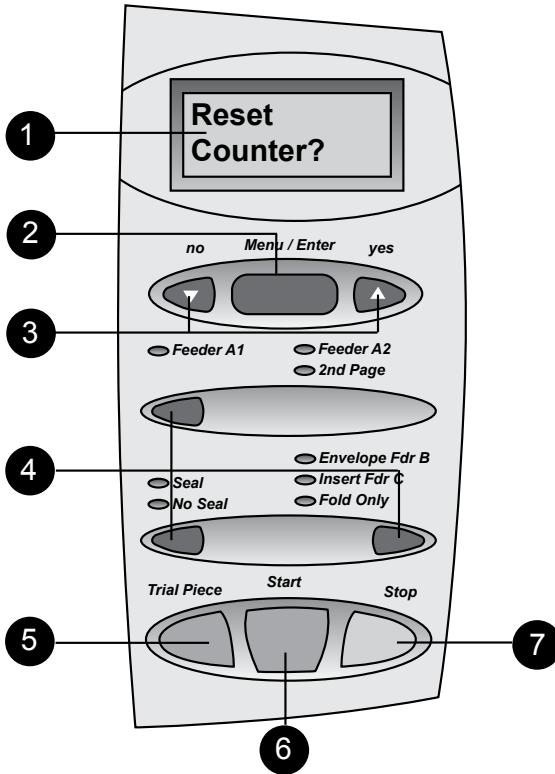

1 Display

Shows the current status of your Relay 1000 and displays prompts and error messages.

2 Menu/Enter (see *Advanced Menu Options* section for details)

Press this button to enter the menu options. Available options:

- Reset Counter
- Change Paper Size (*not available on all configurations*)
- Move Address in Window
- Turn Sheet Double Detection On/Off
- Turn Insert Double Detection On/Off
- Turn Safe Seal On/Off

3 yes (▲) and no (▼) buttons

Once you've entered the menu using Menu/Enter, press these buttons to answer yes or no to prompts and to change (increase or decrease) settings offered by menu options.

4 Selection Buttons and Indicator Lights

Press these buttons to step through the feeders and options that are available on your system.

Depending on your system configuration, some indicator lights and associated feeders may be inoperable. A green indicator means that a feeder or function is selected for use. A red indicator means you selected an invalid combination of functions. When you correct the selection error, the indicator(s) will change back to green. An unlit indicator means that the feeder or function is turned OFF.

5 Trial Piece

Press this button to run one fully collated piece as programmed via the control panel. The envelope will not seal regardless of whether the system has been told to seal or not. This allows you to inspect the processed job to make sure that everything is inserted correctly and that the address appears in the window. The trial piece also allows the system to calibrate itself and set the double detect feature, if selected.

IMPORTANT! Running the trial piece is an essential function for the system to perform. You must do it before you run a new batch of material. This allows the system to re-calibrate for different batches of material.

6 Start

Press to begin automatic operation.

7 Stop

Press to stop automatic operation at the end of the next cycle.

About Sleep Mode

After 10 minutes of inactivity, the system enters a power-saving sleep mode and displays **Powersave On**.

- Press any button to wake up the system.
- The system remembers the last job setup.

1 • System Overview

Advanced Menu Options

To scroll through the menu options

- Press the **Menu/Enter** button repeatedly until you see the option you want. *OR*
- Press the **Menu/Enter** button once and answer no to each of the options as they appear.
- To return to the Ready screen at any time, press the **Menu/Enter** button repeatedly.

Reset Counter

This option allows you to reset the counter to zero. To access it, press the **Menu/Enter** button once. The screen prompts: **Reset Counter?**

- Press yes (▲) to reset the counter and return to the ready screen.
- Press no (▼) to go to the next menu option.

Change Paper Size (Not on All Configurations)

Choose this menu option to select the paper (sheet) size you want to run. You can set your Relay 1000 to process letter-size sheets (8-1/2 x 11 inches) or legal-size sheets (8-1/2 x 14 inches).

1. Press the **Menu/Enter** button repeatedly until the display shows the current paper size selection: **Paper: 8-1/2 x 11 Change Size?** or **Paper: 8-1/2 x 14 Change Size?**
2. Press yes (▲) to change paper size. The display confirms the change. Press no (▼) to go to the next menu option without changing the paper size setting.
3. Press the **Menu/Enter** button repeatedly to go back to the Ready screen.

IMPORTANT! Be sure the sheets you load are the same size you've set the system to run. If you load the wrong size sheets, the system will jam.

Please note that the paper size setting applies to all the sheet feeders: Sheet Feeder A1; the optional Sheet Feeder A2 (if your system is so equipped); and Manual Feeder M.



CAUTION: DO NOT intermix sheet sizes in the same job. The system will jam if you attempt to do so.

Move the Address in the Window

This menu option allows you to change the length of the fold panel so that the address is centered in the envelope window. Make the adjustment by entering a number from 1 to 9. The higher the number, the higher the address will appear in the window. The screen displays: **Shift...X** (where X is the current setting).

1. Press the **Menu/Enter** button repeatedly until the display shows: **Move Address in Window?**
2. Press yes (**▲**) to enter the function. The screen displays: **Shift... X**. (X is the current setting). Pressing no (**▼**) takes you to the next menu option.
3. Set the desired number using the yes (**▲**) and no (**▼**) buttons.
4. When you reach the setting you want, press the **Menu/Enter** button to confirm it. This takes you to the next menu option.
5. Run another trial piece and check it.
 - If the address is centered in the window, press **Start** to run your job.
 - If the address is not centered, repeat the procedure until you get the result you want.

Sheet Double Detect On/Off

Use this option to turn sheet feeder double detection (Sheet DD) on or off.

- **When Double Detect is turned on** - the system stops automatically when it senses a double feed (two sheets feed when only one should). If you're running a job with individually addressed sheets, it's best to turn double detection on.
 - **When Double Detect is turned off** - the system ignores any double feeds that may occur. You may want to leave double detection off if you are running a mail job and occasional duplicate inserts are not a concern.
1. Press the **Menu/Enter** button repeatedly until the display shows the sheet DD status: **Sheet DD is On (Off). Change?**
 2. Press yes (**▲**) to change the sheet double detect status. The display will confirm the change. Or, Press no (**▼**) to go to the next menu option without changing this setting.

1 • System Overview

Insert Double Detect On/Off

Use this option to turn insert feeder double detection (Insert DD) on or off.

- **When Double Detect is turned on** - the system records the thickness of the piece. When you start the run, the system automatically stops when it senses a double feed.
 - **When Double Detect is turned off** - the system ignores any double feeds that may occur. You may want to leave double detection off if you are running a mail job and occasional duplicate inserts are not a concern.
1. Press the **Menu/Enter** button repeatedly until the display shows the insert DD status: **Insert DD is On (Off). Change?**
 2. Press yes (▲) to change the insert double detect setting. The display confirms the change. Or, press no (▼) to go to the next option. The double detection setting remains unchanged.

Safe Seal On/Off

This option allows you to turn safe seal on or off. If you're having problems with envelope flaps not sticking, try turning this option on.

Safe seal slows the system slightly, allowing more time for moisture to transfer onto the envelope flap during the seal cycle. Some gums require this added time to break down properly and become sticky. This function produces a better seal on many types of envelopes.

1. Press the **Menu/Enter** button repeatedly until the display shows the safe seal status: **Safe Seal is On (Off). Change?**
2. Press yes (▲) to change the safe seal status. The display confirms the change. Or, press no (▼) to exit from the menu options without changing the safe seal setting.

2 • System Setup

Contents

Preparing and Loading	2-3
Connecting Power and Turning On	2-3
Fill the Moistener	2-4
Loading the Sheet Feeders (Feeders A1 and A2).....	2-5
Loading the Envelope Feeder (Feeder B)	2-6
Remove/Install the Stacker.....	2-8

This page is intentionally blank.

Preparing and Loading

Once you understand the subjects covered in this chapter, you can quickly set up and use the system for a variety of jobs as explained later in the Running Jobs section.

IMPORTANT! Before running a job, make sure your material meets our published specifications (refer to the Specifications chapter). This helps assure reliable operation and greatest productivity.

Connecting Power and Turning On

WARNING! Read all the safety information at the beginning of this guide before connecting the system.

1. Connect the power cord to the socket on the back of the system.
 2. Plug the power cord into an easily accessible power outlet.
 3. Turn the power switch ON.
 - After a few seconds, the message “Check Moistener” appears on the display. This is only a reminder to check the level; it does not always mean that the moistener level is too low.
 - The “Check Moistener” message remains there until any other button is pressed.
- IMPORTANT!** As an additional reminder, the “Check Moistener” message appears every 1,000 cycles, at the end of a batch or when the Stop button is pressed.
- When turned ON, the system remembers the last job setup, and automatically resets the item counter to zero.

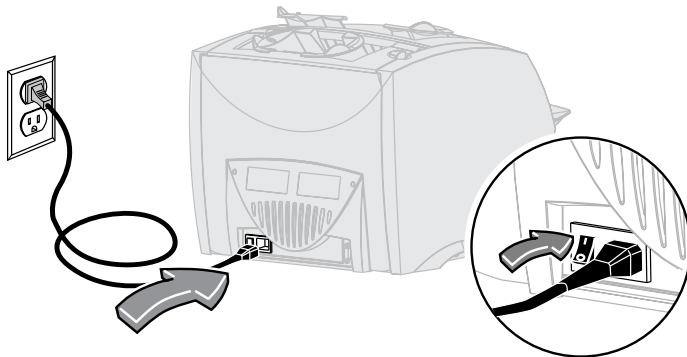

2 • System Setup

Fill the Moistener

The oval window on the front of the moistener provides an easy view of the current fluid level. When the fluid gets low, refill the moistener.

1. Slide the moistener out to the right.

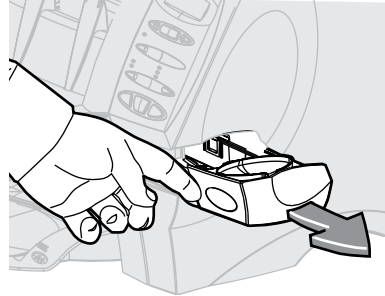

IMPORTANT! Never open the moistener while the system is processing material.

2. Carefully fill the moistener with E-Z Seal® solution or water up to the “Max” mark in the filler funnel. We recommend E-Z Seal® to minimize algae growth and scale buildup.

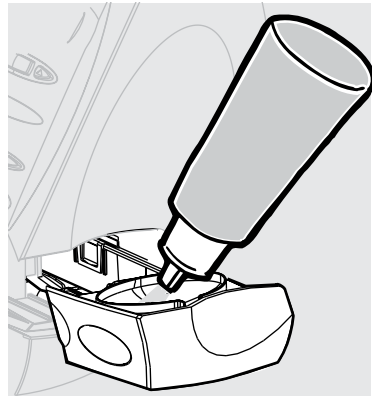

3. Slide the moistener back into the system. From a dry state, the moistener takes about five minutes to become fully wet and ready for use.

Loading the Sheet Feeders (Feeders A1 and A2)

- Sheet Feeder A1 is common to all models and located below Manual Feeder M.
- Sheet Feeder A2 is an option on all models. It allows the system to insert a second folded sheet into an envelope.
- Both feeders are used for sheets that require folding before inserting.
- Load both feeders in exactly the same way.

1. Always fan (aerate) sheets before you load them. This prevents them from sticking together.
2. Tap the stack of sheets onto a firm surface to align the edges.
3. Place the sheets into Sheet Feeder A1 or A2 as required.

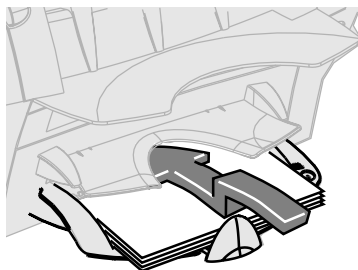
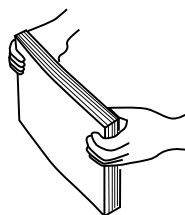

IMPORTANT! Always load sheets into these feeders face down and bottom edge first. The bottom edge of the sheet is furthest into the system.

NOTE: If you use Sheet Feeders A1 and A2 at the same time, you must load the document printed with the address into Sheet Feeder A2. If you load the address-bearing document into Sheet Feeder A1, the address will not be visible in the envelope window.

4. Slide the back stop in until it just touches the paper stack.

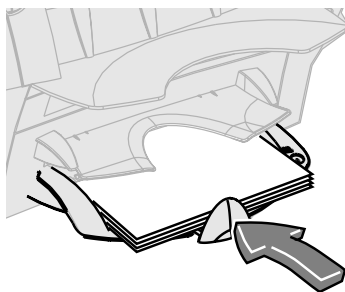

2 • System Setup

Loading the Envelope Feeder (Feeder B)

1. Always fan (aerate) envelopes before you load them. This prevents them from sticking together.
2. Tap the stack of envelopes onto a firm surface to align the edges.
3. Place the envelope stack into Feeder B with the last envelope flat against the feed belts. You do not need to “shingle” or stagger the envelope stack. The feeder can hold up to 60 envelopes.

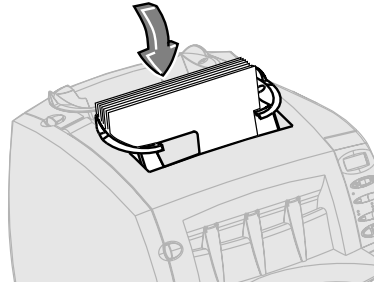
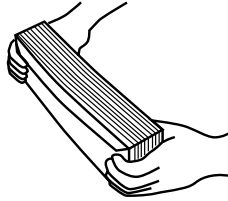

IMPORTANT! Load envelopes right way up and facing you. This means that the envelope flap is on the back of the envelope and at the top. Any other orientation will prevent the machine from inserting properly.

4. Slide the two side guides up to the envelope stack then slightly back them off. Use the blue handles at the rear of the guides when moving them.

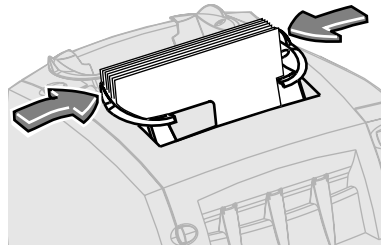

IMPORTANT! The setting is correct when the guides do not restrict the envelopes feeding into the system or cause them to feed at an angle (skew).

Loading the Insert Feeder (Feeder C)

If your system has Insert Feeder C, use this feeder to add additional inserts to your envelope that do not require folding by the machine. Feeder C is especially suited to feeding pre-folded or thicker inserts, such as business reply envelopes (BREs), response cards and similar materials.

1. Always fan (aerate) inserts before you load them. This prevents them from sticking together.
2. Tap the stack of inserts onto a firm surface to align the edges.
3. Place the insert stack into Feeder C.

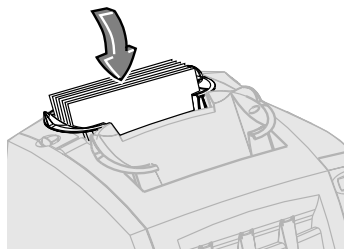
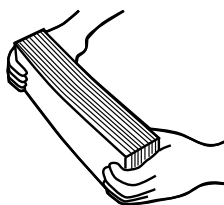

IMPORTANT!

- For pre-folded inserts, it's normally best to load with the "closed" edge feeding first.
 - You can usually load business reply envelopes right way up and facing you. However, if the flaps are pulled open when feeding, try loading the envelopes with the flaps down and facing you.
4. Slide the two side guides up to the insert stack, then slightly back them off. Use the blue handles at the rear of the guides when moving them.

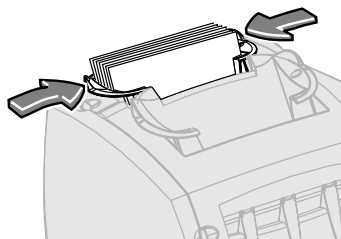

IMPORTANT! The setting is correct when the guides do not restrict the envelopes feeding into the system or cause them to feed at an angle (skew).

2 • System Setup

Remove/Install the Stacker

To *remove* the stacker:

1. Pivot the stacker up slightly.
2. Pull the stacker away from the system.

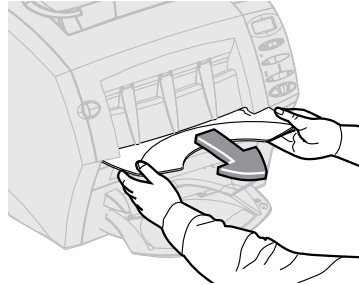

To *install* the stacker:

1. Place the stacker pivots against the mounting studs.
2. Push the stacker gently until it snaps into position.

3 • *Run a Job*

Contents

Run a Job	3-3
All Models	3-3
Models with an Insert Feeder.....	3-3
Models with an Optional Second Sheet Feeder	3-4
Models with an Insert Feeder and Second Sheet Feeder	3-5
Manual Feeder M	3-16

This page is intentionally blank.

Run a Job

This section assumes you understand the system features and use of the control panel. It includes images that identify the various jobs you can run on the Relay 1000, and a table of quick steps to set up and run each job.

All Models

Job 1

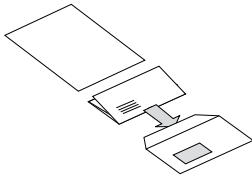

- One Folded Sheet
- Into an Envelope

Job 2

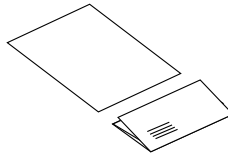

- One Folded Sheet
- No Envelope

Models with an Insert Feeder

Job 3

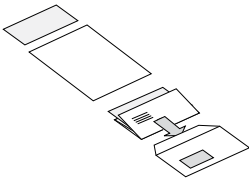

- One Folded Sheet
- One Insert
- Into an Envelope

Job 4

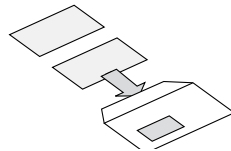

- One Insert
- Into an Envelope

3 • Run a Job

Models with an Optional Second Sheet Feeder

Job 5

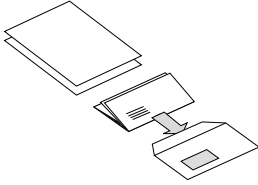

- Two Folded Sheets
- Into One Envelope

Job 6

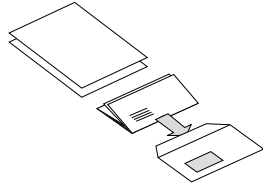

- Two Collated, Folded Sheets
- Into One Envelope

** see note next page*

Job 7

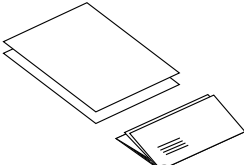

- Two Folded Sheets
- No Envelope

Job 8

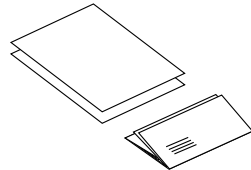

- Two Collated, Folded Sheets
- No Envelope

** see note next page*

Models with an Insert Feeder and Second Sheet Feeder

Job 9

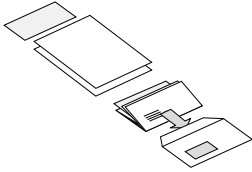

- **Two Folded Sheets**
- **One Insert**
- **Into an Envelope**

Job 10

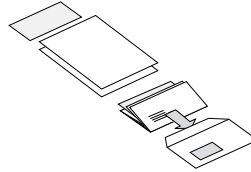

- **Two Collated, Folded Sheets**
- **One Insert**
- **Into an Envelope**

** see note below*

NOTE: Jobs marked with an asterisk (*) use the second sheet feeder, A2, in “2nd Page” mode to feed 2-sheet collated sets. You must load sheets into the feeder in their collated sequence: first page, second page, first page, second page, etc.

3 • Run a Job

Job 1

- One folded sheet
- Into an envelope
- Configuration required: any Relay 1000

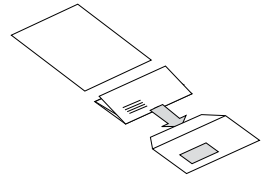

NOTE: If your system has the optional 2nd sheet feeder A2, you can use it instead of A1, as long as you load and select it as described in steps 1 and 3 below.

STEP	ACTION	TIP
1	Make sure the paper size setting is correct. NOTE: This setting is not available on all models.	Select 11" or 14" .
2	Load sheets into Sheet Feeder A1.	Load face down and bottom edge first.
3	Load envelopes in Feeder B.	Load right way up and facing you.
4	Press button to select Feeder A1 .	Make sure indicators are green.
5	Press button to select Envelope Fdr B .	Make sure indicators are green.
6	Press button to choose Seal or No Seal .	Make sure moistener has E-Z Seal® or water.
7	Press Trial Piece button and inspect trial piece.	Trial piece will not seal - this is normal.
8	Press the Start button to run the job.	The Stop button will stop the system at the end of the cycle.

Job 2

- One folded sheet
- No envelope
- Configuration required: any Relay 1000

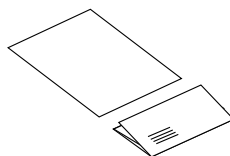

NOTE: If your system has the optional 2nd sheet feeder A2, you can use it instead of A1, as long as you load and select it as described in steps 1 and 3 below.

STEP	ACTION	TIP
1	Make sure the paper size setting is correct. NOTE: This setting is not available on all models.	Select 11" or 14" .
2	Load sheets into Sheet Feeder A1.	Load face down and bottom edge first.
3	Press the button to select Feeder A1 .	Make sure indicators are green.
4	Press button to select Fold Only .	Make sure indicators are green.
5	Press the Trial Piece button and inspect trial piece.	Check trial piece for a good fold.
6	Press the Start button to run job.	The Stop button will stop the system at the end of the cycle.

3 • Run a Job

Job 3

- One folded sheet
- One insert
- Into an envelope
- Configuration required: Relay 1000 with Insert Feeder C

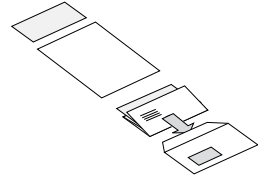

NOTE: Inserts are pre-folded sheets or unfolded items such as business reply envelopes, response cards and similar items. If your system has the optional 2nd sheet feeder A2, you can use it instead of Feeder A1, as long as you load and select it as described in steps 1 and 4 below.

STEP	ACTION	TIP
1	Make sure the paper size setting is correct. NOTE: This setting is not available on all models.	Select 11" or 14" .
2	Load sheets into Sheet Feeder A1.	Load face down and bottom edge first.
3	Load envelopes in Feeder B.	Load right way up and facing you.
4	Load inserts into Insert Feeder C.	Loading orientation depends on item.
5	Press button to select Feeder A1 .	Make sure indicators are green.
6	Press button to select Envelope Fdr B and Insert Fdr C .	Make sure BOTH green indicators are lit.
7	Press button to choose Seal or No Seal .	Make sure moistener has E-Z Seal® or water.
8	Press the Trial Piece button and inspect trial piece.	Trial piece will not seal - this is normal.
9	Press the Start button to run job.	The Stop button will stop the system at the end of the cycle.

Job 4

- One insert
- Into an envelope
- Configuration required: Relay 1000 with Insert Feeder C

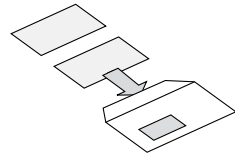

NOTE: Inserts are pre-folded sheets or unfolded items such as business reply envelopes, response cards and similar materials.

STEP	ACTION	TIP
1	Load envelopes into Feeder B.	Load right way up and facing you.
2	Load inserts into Insert Feeder C.	Loading orientation depends on the item.
3	Press button to select Envelope Fdr B and Insert Fdr C .	Make sure BOTH green indicators are lit.
4	Press A1/A2 select button until both feeders and 2nd Page are turned OFF .	Make sure NO indicators lights are lit for A1 or A2 or 2nd page.
5	Press button to choose Seal or No Seal .	Make sure moistener has E-Z Seal® or water.
6	Press the Trial Piece button and inspect trial piece.	Trial piece will not seal - this is normal.
7	Press the Start button to run job.	The Stop button will stop the system at the end of the cycle.

3 • Run a Job

Job 5

- Two Folded Sheets
- Into One Envelope
- Configuration required: Relay 1000 with optional Sheet Feeder A2

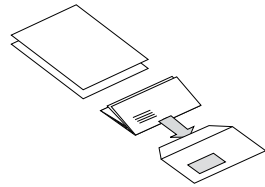

NOTE: Run the address-bearing document from Sheet Feeder A2 and a second sheet that needs folding from Sheet Feeder A1.

STEP	ACTION	TIP
1	Make sure the paper size setting is correct. NOTE: This setting is not available on all models.	Select 11" or 14" .
2	Load addressed sheets into Sheet Feeder A2.	Load face down and bottom edge first.
3	Load second sheets into Sheet Feeder A1.	Load face down and bottom edge first.
4	Load envelopes in Feeder B.	Load right way up and facing you.
5	Press button to select Feeder A1 and A2 .	Make sure BOTH green indicators are lit.
6	Press button to select Envelope Fdr B .	Make sure indicators are green.
7	Press button to choose Seal or No Seal .	Make sure moistener has E-Z Seal® or water.
8	Press the Trial Piece button and inspect trial piece.	Trial piece will not seal- this is normal.
9	Press the Start button to run job.	The Stop button will stop the system at the end of the cycle.

Job 6

- Two collated, folded sheets
- Into one envelope
- Configuration required: Relay 1000 with optional Sheet Feeder A2

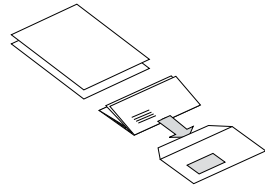

NOTE: This job uses the second sheet feeder A2 in 2nd Page mode to feed two-sheet, collated sets. Load sheets into the feeder in their collated sequence: page one, page two, page one, page two and so on.

STEP	ACTION	TIP
1	Make sure the paper size setting is correct. NOTE: This setting is not available on all models.	Select 11" or 14" .
2	Load sheets into Sheet Feeder A2. (<i>See note above for loading sequence.</i>)	Load face down and bottom edge first.
3	Load envelopes in Feeder B.	Load right way up and facing you.
4	Press button to select Feeder A2 and 2nd Page.	Make sure BOTH green indicators are lit.
5	Press button to select Envelope Fdr B.	Make sure indicators are green.
6	Press button to choose Seal or No Seal.	Make sure moistener has E-Z Seal® or water.
7	Press the Trial Piece button and inspect trial piece.	Trial piece will not seal- this is normal.
8	Press the Start button to run job.	The Stop button will stop the system at the end of the cycle.

3 • Run a Job

Job 7

- Two folded sheets
- No envelope
- Configuration required: Relay 1000 with optional Sheet Feeder A2.

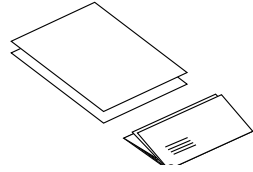

NOTE: Run the address bearing document from Sheet Feeder A2 and a second sheet that needs folding from Sheet Feeder A1.

STEP	ACTION	TIP
1	Make sure the paper size setting is correct. NOTE: This setting is not available on all models.	Select 11" or 14" .
2	Load addressed sheets into Sheet Feeder A2.	Load face down and bottom edge first.
3	Load second sheets in Sheet Feeder A1.	Load face down and bottom edge first.
4	Press button to select Feeder A1 and Feeder A2 .	Make sure BOTH green indicators are lit.
5	Press button to select Fold Only .	Make sure indicators are green.
6	Press the Trial Piece button and inspect trial piece	Check trial piece for good fold.
7	Press the Start button to run job.	The Stop button will stop the system at the end of the cycle.

Job 8

- Two collated, folded sheets
- No envelope
- Configuration required: Relay 1000 with optional Sheet Feeder A2.

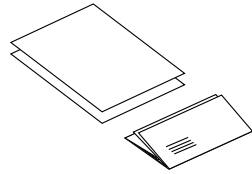

NOTE: This job uses the second sheet feeder A2 in 2nd Page mode to feed two-sheet, collated sets. Load sheets into the feeder in their collated sequence: page one, page two, page one, page two and so on.

STEP	ACTION	TIP
1	Make sure the paper size setting is correct. NOTE: This setting is not available on all models.	Select 11" or 14" .
2	Load sheets into Sheet Feeder A2. See above for loading sequence.	Load face down and bottom edge first.
3	Press button to select Feeder A2 and 2nd Page .	Make sure BOTH green indicators are lit.
4	Press button to select Fold Only .	Make sure indicators are green.
5	Press the Trial Piece button and inspect trial piece	Check trial piece for a good fold.
6	Press the Start button to run job.	The Stop button will stop the system at the end of the cycle.

3 • Run a Job

Job 9

- Two folded sheets
- One insert
- Into an envelope
- Configuration required: Relay 1000 with Insert Feeder C and optional Sheet Feeder A2

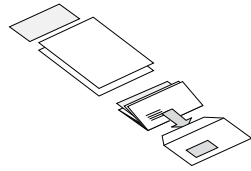

NOTE: Run the address-bearing document from Sheet Feeder A2 and a second sheet that needs folding from Sheet Feeder A1. Inserts are pre-folded sheets or unfolded items such as business reply envelopes, response cards and similar materials.

STEP	ACTION	TIP
1	Make sure the paper size setting is correct. NOTE: This setting is not available on all models.	Select 11" or 14" .
2	Load addressed sheets into Sheet Feeder A2.	Load face down and bottom edge first.
3	Load second sheets into Sheet Feeder A1.	Load face down and bottom edge first.
4	Load envelopes in Feeder B.	Load right way up, facing you.
5	Load inserts into Insert Feeder C.	Loading orientation depends on item.
6	Press button to select Feeder A1 and Feeder A2.	Make sure BOTH green indicators are lit.
7	Press button to select Envelope Fdr B and Insert Fdr C.	Make sure BOTH green indicators are lit.
8	Press button to choose Seal or No Seal.	Make sure moistener has E-Z Seal® or water.
9	Press the Trial Piece button and inspect trial piece	Trial piece will not seal - this is normal.
10	Press the Start button to run job.	The Stop button will stop the system at the end of the cycle.

Job 10

- Two collated, folded sheets
- One insert
- Into an envelope
- Configuration required: Relay 1000 with Insert Feeder C and optional Sheet Feeder A2

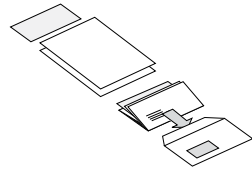

NOTE: This job uses the second sheet feeder A2 in 2nd Page mode to feed two-sheet, collated sets. Load sheets into the feeder in collated sequence: first page, second page, first page, second page and so on. Inserts are pre-folded sheets or unfolded items such as business reply envelopes, response cards and so on.

STEP	ACTION	TIP
1	Make sure the paper size setting is correct. NOTE: This setting is not available on all models.	Select 11" or 14" .
2	Load addressed sheets into Sheet Feeder A2. See notes above for loading sequence.	Load face down and bottom edge first.
3	Load second sheets into Sheet Feeder B.	Load face down and bottom edge first.
4	Load inserts into Insert Feeder C.	Loading orientation depends on item.
5	Press button to select Feeder A2 and 2nd Page .	Make sure BOTH green indicators are lit.
6	Press button to select Envelope Fdr B and Insert Fdr C .	Make sure BOTH green indicators are lit.
7	Press button to choose Seal or No Seal .	Make sure moistener has E-Z Seal® or water.
8	Press the Trial Piece button and inspect trial piece	Trial piece will not seal - this is normal.
9	Press the Start button to run job.	The Stop button will stop the system at the end of the cycle.

3 • Run a Job

Manual Feeder M

Relay 1000 models have a Manual Feeder M that allows you to feed stapled sets of up to three sheets of 20 pound bond (80 g/m²). The sets are fed by hand, one set at a time, for processing by the system. When you use the manual feeder, the system automatically turns off both sheet feeders. You can, however, use the manual feeder along with the envelope, insert, fold-only and sealer selections to run a variety of jobs manually.

To use the manual feeder:

1. Set up the system as you normally would for the job you are running. The selections shown by the indicators for Sheet Feeders A1 and/ or A2 are ignored by the system. All other selections apply to the manual job.
2. Feed one staple set, *face down* and *bottom edge first*, gently into the manual feed slot. The system automatically starts and draws the set from you. The system processes the set and ejects it into the stacker in the usual manner.

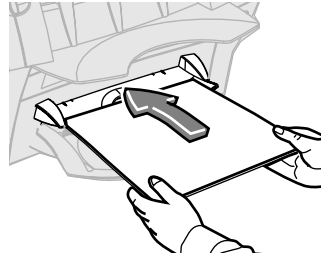

NOTES:

- Be sure to feed the set into the system squarely and gently. If you feed it in at an angle or with force, a poor fold or jam could result.
- The first set will not seal even if you set up the system to do so. This "trial" feature allows you to inspect the processed job to make sure that all pieces were inserted correctly and that the address appears in the envelope.



CAUTION! Feeding more than three sheets in a set may damage your system.

4 • *Clear Material*

Contents

Clear Material Jams.....	4-3
--------------------------	-----

This page is intentionally blank.

Clear Material Jams

1. Remove all paper from the affected feeders that are indicated on the display.
2. If necessary, clear sheets from the affected feeder.
 - If the display indicates a jam in the *sheet feeder(s)* or *manual feeder* areas, pull the feeder assembly from the inserter as shown, and then carefully remove any stalled material.

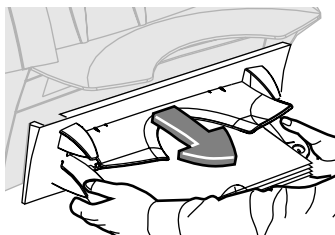

- If the display indicates a jam beneath *cover D*, press the blue button marked D to release the cover. Lift the cover using the finger grips on each side of the stacker, and then carefully remove any stalled material.
- When closing the cover, latch it closed by pressing down on the finger grips or the central part of the cover in front of the envelope feeder. **DO NOT** press down on the stacker.

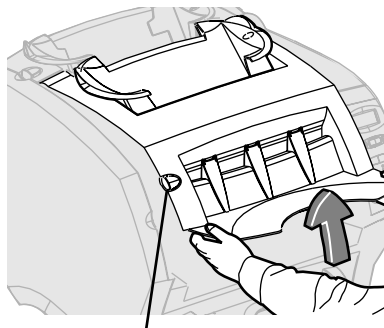

Button D

- If the display indicates a jam beneath *cover E*, press the blue button marked E to release the cover. Push the cover backwards to gain full access, then carefully remove any stalled material.

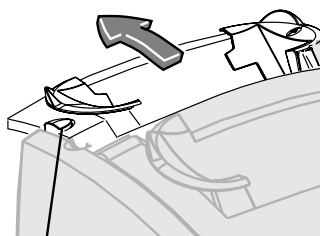

Button E

This page is intentionally blank.

5 • *Troubleshooting and Error Messages*

Contents

General Troubleshooting	5-3
Error Messages	5-5

This page is intentionally blank.

General Troubleshooting

Issue	Possible Solutions
Poor Folding System creates a “box fold” when another fold is created off the perforation and buckles slightly, creating, in effect, a third fold.	<ol style="list-style-type: none">1. Adjust the system fold slightly.2. Run a trial piece and inspect the fold.3. If there is still a box fold, access the advanced menu options and select <i>move address in window</i>.4. Change the setting higher or lower and re-run a trial piece.5. Inspect the fold again and, if required, change the move address in window function until the box fold is eliminated.
System stops for doubles that aren't there.	<ul style="list-style-type: none">• If you are running a new batch of material that is slightly thicker or thinner than the original material, run a new trial piece to allow the system to recalibrate to the new material.• Another possible solution is to turn off double detection if an occasional duplicate insert is not important.
System feeds doubles without stopping.	<ol style="list-style-type: none">1. Make sure double detection is turned on.2. Run a trial piece. This automatically sets the double detector.
Envelope flaps won't seal	<p>Try one or all of the following:</p> <ul style="list-style-type: none">• Verify Seal is selected (green indicator lit).• Make sure the moistener isn't empty.• Select safe seal mode.
Address position is wrong or address doesn't appear in envelope window.	<ul style="list-style-type: none">• Make sure the addressed sheet loaded properly.• Make sure the addressed sheet in Sheet feeder A2 (if installed).• Try adjusting the address position.

5 • Troubleshooting and Error Messages

Issue	Possible Solutions
Inserts or business reply envelopes feed poorly from the Insert Feeder	Changing the orientation of the insert stack may help. <ul style="list-style-type: none">• For pre-folded inserts, it is normally best to load with the closed edge feeding first.• Business reply envelopes can normally be loaded right way up and facing you. However, if the flaps are pulled open when feeding, try loading with the flaps down and facing you.
Following installation of Sheet Feeder 2, the system doesn't work	Make sure the system is seated correctly on Sheet Feeder 2. <ul style="list-style-type: none">• Turn the system off, wait a few seconds and then turn it back on.• Remove any debris (dust, paper, etc.) from the Sheet Feeder 2 electrical connector.

Error Messages

Message	Cause and Fix
CANNOT SHIFT ADDRESSES ON INSERT	No sheet feeder has been selected in the job setup. The display automatically times out from this message after two seconds and displays the double detect On/Off menu function.
CLOSE COVER D	The system has detected that the front cover D is open. Make sure cover D is closed properly.
CLOSE COVER E	The system has detected that the front cover E is open. Make sure cover E is closed properly.
CHECK AREAS A1 & D	Check for an unsuccessful clearance of a jam between the sheet feeder A1 and the area under cover D. <ol style="list-style-type: none">1. Remove the paper in sheet feeder A1.2. Open front cover D and make sure the system is clear of material.3. Close front cover D.4. Reload and then start the run.
CHECK AREAS A1, A2, & D	This could be due to an unsuccessful clearance of a jam between the sheet feeders A1, A2 and the area under cover D. <ol style="list-style-type: none">1. Remove paper in sheet feeders A1 and A2.2. Open front cover D and make sure the system is clear of material.3. Close front cover D.4. Reload and then start the run.
CHECK/CLEAR INSERT FDR C	Inserts failed to feed. <ol style="list-style-type: none">1. Make sure the side guides in insert feeder C are set correctly.2. Reload feeder C and then start the run.
CHECK SHEET FEEDER A1	Sheet feeder A1 is out of paper, failed to feed or a jam wasn't cleared successfully from area. <ol style="list-style-type: none">1. Remove the paper in sheet feeder A1.2. Reload and then start the run.

5 • Troubleshooting and Error Messages

Message	Cause and Fix
CHECK SHEET FEEDER A2	<p>Sheet feeder A2 is out of paper, failed to feed, or a jam was not cleared successfully from this area.</p> <p>If there are sheets in the feeder:</p> <ol style="list-style-type: none">1. Remove the paper in sheet feeder A2.2. Reload and then start the run. <p>If the feeder is empty, load sheets.</p>
CHECK SHEET FEEDER A2 LIFT COVER D REMOVE ALL	<p>The system has detected a material jam between sheet feeder A2 and the area under cover D.</p> <ol style="list-style-type: none">1. Open the front cover D and remove all material inside.2. Close front cover D.3. Remove material from sheet feeder A2.4. Reload and start the run.
CLEAR FEEDER M	<p>The Manual Feeder M was blocked before powering up the system or starting the run.</p> <ol style="list-style-type: none">1. If there is any material in the feeder, remove it.2. Restart the system.
CLEAR STACKER AREA	<p>Check for a jam in the stacker area.</p> <ol style="list-style-type: none">1. Remove any material from the stacker area.2. Resume the run.
DOUBLE FEED CHECK FDR A1	<p>The system has detected a double feed from sheet feeder A1.</p> <ol style="list-style-type: none">1. Remove the paper in sheet feeder A1.2. Reload and then start the run.
DOUBLE FEED CHECK FDR A2	<p>The system has detected a double feed from sheet feeder A2.</p> <ol style="list-style-type: none">1. Remove paper in sheet feeder A2: make sure to remove any partially fed sheets.2. Reload and then start the run.

Troubleshooting and Error Messages • 5

Message	Cause and Fix
FOLD ONLY REQUIRES SHEETS	Fold only has been selected but no sheets, either from feeder A1 or A2 (if applicable), have been selected. In this state the indicators for sheet feeder A1 will be red. Press the sheet feeder selection button until the required feeder is selected.
INSERT DOUBLE FEED	The system has detected a double feed from the insert feeder. <ol style="list-style-type: none"><li data-bbox="394 488 589 516">1. Lift cover D.<li data-bbox="394 532 657 560">2. Remove material.<li data-bbox="394 576 891 604">3. Reload inserts and then start the run.
LIFT COVER D REMOVE ALL	There is a jam in or near the insertion area, or a previous jam was not cleared correctly. It can also be caused by dust covering a sensor. <ol style="list-style-type: none"><li data-bbox="394 721 682 748">1. Open front cover D.<li data-bbox="394 764 876 792">2. Remove any material in the system.<li data-bbox="394 808 838 862">3. Blow out any dust that may have accumulated in the area.<li data-bbox="394 878 887 906">4. Close cover D and then start the run.
LIFT COVER D REMOVE ENV	Check for an envelope jam under cover D. <ol style="list-style-type: none"><li data-bbox="394 959 682 987">1. Open front cover D.<li data-bbox="394 1003 929 1057">2. Remove the envelope and then start the run. If no envelope is visible:<ul data-bbox="444 1073 929 1170" style="list-style-type: none"><li data-bbox="444 1073 929 1127">• Remove all material that is visible in the feeder.<li data-bbox="444 1143 791 1170">• Reload and start the run.
NVM ERROR CALL SERVICE	This is an unrecoverable error with the system software. Call Pitney Bowes for assistance.
OPEN COVER E REMOVE ALL	Check for a jam under cover E. <ol style="list-style-type: none"><li data-bbox="394 1312 614 1339">1. Open cover E.<li data-bbox="394 1356 873 1383">2. Remove any material in the system.<li data-bbox="394 1399 937 1427">3. Close rear cover E and then start the run.

5 • Troubleshooting and Error Messages

Message	Cause and Fix
SYSTEM ERROR POWER ON/OFF	<ol style="list-style-type: none">1. Turn off power to the system.2. Wait a minute and turn the power back on.
RELOAD ENVELOPES	<p>Feeder B may be out of envelopes, or an envelope feed failed or was slow.</p> <ol style="list-style-type: none">1. Make sure there are envelopes loaded.<ul style="list-style-type: none">• If not, reload and then start the run.• If there are envelopes loaded, make sure that the side guides on feeder B are not too tight and that no more than 60 envelopes are loaded.2. Reload feeder B and then start the run.
RELOAD INSERT FEEDER C	<p>Insert feeder C is empty. Reload inserts and start the run.</p>
REMOVE ALL FROM D & E	<p>This could be due to a material jam in fold plate 1 or near the insertion area.</p> <ol style="list-style-type: none">1. Open front cover D.2. Remove any material from the area.3. Close cover D.4. Open rear cover E.5. Remove any material from the area.6. Close rear cover E and then start the run.

Troubleshooting and Error Messages • 5

Message	Cause and Fix
REMOVE ALL FROM M & D	There was a poor feed from manual feeder M. <ol style="list-style-type: none"><li data-bbox="394 256 960 318">1. If there is any material in manual feeder M, remove it.<li data-bbox="394 331 960 393">2. Open front cover D and remove any material.<li data-bbox="394 406 960 435">3. Close front cover D.<li data-bbox="394 448 960 477">4. Reload and then start the run.
REMOVE SHEET FROM A1	A sheet has failed to feed from sheet feeder A1. <ol style="list-style-type: none"><li data-bbox="394 529 960 558">1. Remove paper from A1.<li data-bbox="394 571 960 600">2. Reload and then start the run.
REPLACE FDR A1 TRAY	Make sure that sheet feeder A1 is pushed fully into position.
SHEETS REQUIRED	<ul style="list-style-type: none"><li data-bbox="394 691 960 753">• Envelopes have been selected but no sheet feeder was selected.<li data-bbox="394 766 960 828">• The indicators for sheet feeder A1 and envelopes will be red. <p data-bbox="394 841 960 902">Press the sheet feeder selection button until the required feeder is selected.</p>
SYSTEM ERROR CALL SERVICE	This is an unrecoverable system error. Call Pitney Bowes for assistance.

This page is intentionally blank.

6 • *Specifications*

Contents

Specifications - U.S.	6-3
Material Specifications - U.S.	6-3
System Specifications - U.S.	6-5
Specifications - International	6-6
Material Specifications - International	6-6
System Specifications - International	6-8

This page is intentionally blank.

Specifications - U.S.

Material Specifications - U.S.

Sheet Feeders A1 and/or A2

Sheet Size:	Letter (8-1/2 x 11") or Legal (8-1/2 x 14")
Paper Weight:	20 to 24 lb. bond
Capacity:	Max: 80 sheets of 20 lb. bond
Type:	Suitable for normal copier/laser printer bond paper. DO NOT run perforated, NCR or coated papers.

Insert Feeder C (optional)

Insert Size:	Width: 5 to 8-3/4"
	Depth: 3-3/8 to 3-7/8"
Material Weight:	Unfolded document: 18 lb. bond to 80 lb. card stock
	Tri-folded document: 18 to 24 lb. bond
Capacity:	Max: 60 Business Reply Envelopes, 24 lb bond
Type:	Suitable for pre-folded, single panel inserts, business reply envelopes, etc.

Envelope Feeder B

Envelope Size:	Number 10 only
	Width: 9-1/2"
	Depth: 4-1/8"
Material Weight:	18 to 24 lb. bond
Capacity:	Max: 60 envelopes, 24 lb. bond
Envelope Flap Type:	Executive (triangular) flap
Envelope Flap Length:	1-1/4" to 2-1/4"

6 • Specifications

End Clearance	End clearance between the contents and envelope must be a minimum of 1/4" on each side (1/2" overall). Take this measurement with <i>all</i> contents placed into the envelope.
Depth Clearance	The contents must allow a minimum clearance of 1/4" below the flap crease after full insertion into the envelope.

Manual Feeder M

Stapled or unstapled sets of up to 3 sheets of 20 lb. bond paper can be processed. Sheet Feeders A1 and A2 cannot be used in conjunction with the Manual Feeder. Glossy/coated sheets are not recommended.

Sealer Capacity

The machine can seal up to a maximum of 1,000 envelopes between refills.

Stacker

Stacker capacity is up to 60 filled envelopes, depending on the contents of envelope.

Material Requirements

- Materials should be of good quality and properly stored
- Recommended storage conditions:
 - 64° to 77°F
 - 40 to 60% relative humidity

System Specifications - U.S.

Physical Dimensions

Width:	17-3/8"
Depth:	20-3/4"
Height:	14-3/8" without sheet feeder 2 17-3/8" with sheet feeder 2
Weight:	38 lb.

Noise Level: Running: <70dBA

Electrical 115V, 60Hz, 2.4A

Speed Up to a maximum of 900 cycles per hour

Duty Cycle

Up to a maximum of 4,000 cycles per month with an average of 2,000 cycles per month and a maximum life of 120,000 cycles.

NOTE: All specifications are subject to change without notification and are for information only.

6 • Specifications

Specifications - International

Material Specifications - International

Sheet Feeders A1 and/or A2

Sheet Size:	DIN A4 (297mm x 210mm)
Paper Weight:	75gsm to 90gsm bond
Capacity:	Max: 80 sheets of 80gsm bond
Type:	Suitable for normal copier/laser printer bond paper. DO NOT run perforated, NCR or coated papers.

Insert Feeder C (optional)

Insert Size:	Width: 127mm to 225mm Depth: 86mm to 114mm
Material Weight:	Unfolded document: 70gsm bond to 200gsm card stock Trifolded document: 70gsm to 90gsm bond
Capacity:	Max: 60 Business Reply Envelopes, 90gsm bond
Type:	Suitable for pre-folded, single panel inserts, business reply envelopes, etc.

Envelope Feeder B

Envelope Size:	DL Mailer only Width: 225mm to 235mm Depth: 110mm to 121mm
Material Weight:	70gsm to 90gsm bond
Capacity:	Max: 60 envelopes, 90gsm bond
Envelope Flap Type:	Mailing wallet style flap (shown here)

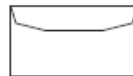

Envelope Flap Length: 32mm to 57mm

End Clearance	End clearance between the contents and envelope must be a minimum of 5mm on each side (10mm overall). Take this measurement with all contents placed into the envelope
Depth Clearance	The contents must allow a minimum clearance of 6mm below the flap crease after full insertion into the envelope.

Manual Feeder M

Stapled or unstapled sets of up to 3 sheets of 80gsm bond paper can be processed. Sheet Feeders A1 and A2 cannot be used in conjunction with the Manual Feeder. Glossy/coated sheets are not recommended.

Sealer Capacity

The machine can seal up to a maximum of 1,000 envelopes between refills.

Stacker

Stacker capacity is up to 60 filled envelopes, depending on the contents of envelope.

Material Requirements

- Materials should be of good quality and properly stored
- Recommended storage conditions:
 - 18° to 25°C
 - 40 to 60% relative humidity

6 • Specifications

System Specifications - International

Physical Dimensions

Width:	440mm
Depth:	440mm
Height:	365mm without sheet feeder 2 440mm with sheet feeder 2
Weight:	17kg

Noise Level Running: <70dBA

Electrical 240V, 50Hz, 1A

Speed Up to a maximum of 900 cycles per hour

Duty Cycle

Up to a maximum of 4,000 cycles per month with an average of 2,000 cycles per month and a maximum life of 120,000 cycles.

NOTE: All specifications are subject to change without notification and are for information only.

-

This page is intentionally blank.

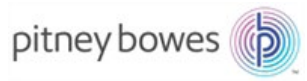

3001 Summer Street
Stamford, CT 06926-0700
www.pitneybowes.com

SV63176 RevB
©2016 Pitney Bowes Inc.
All Rights Reserved