



Shipping & Mailing
Inserter

Relay™ 2000

Document Inserting System

Operator Guide

International English Edition

SV63139 Rev C

July 18, 2016

Statement of FCC Compliance

This equipment has been tested and found to comply with the limits for a Class A digital device, pursuant to part 15 of the FCC rules. These limits are designed to provide reasonable protection against interference when the equipment is operated in a commercial environment. This equipment generates, uses, and can radiate radio frequency energy and, if not installed and used in accordance with the instruction manual, may cause interference to radio communications. Operation of this equipment in a residential area is likely to cause interference, in which case the user will be required to correct the interference at his own expense.

CAUTION: Changes or modifications to this equipment not expressly approved by the party responsible for compliance (Pitney Bowes) could void the user's authority to operate the equipment.

Canada

This class A digital apparatus complies with Canadian ICES-003.

Cet appareil numérique de la classe A est conforme à la norme NMB-003 du Canada.



It is certified that this system complies with all applicable Directives of the European Union.

SV63139 Rev. C ©2006, 2016 Pitney Bowes Inc.

All rights reserved. This book may not be reproduced in whole or in part in any fashion or stored in a retrieval system of any type or transmitted by any means, electronically or mechanically, without the express, written permission of Pitney Bowes. We have made every reasonable effort to ensure the accuracy and usefulness of this manual; however, we cannot assume responsibility for errors or omissions or liability for the misuse or misapplication of our products.

Due to our continuing program of product improvement, equipment and material specifications as well as performance features are subject to change without notice. E-Z Seal is a registered trademark of Pitney Bowes.

Safety	vii
--------------	-----

Chapter 1: System Overview

Relay 2000 Inserter Overview	1-3
Product Features	1-3
Inserter Component Identification	1-4
Inserter Control Panel Identification	1-6
Inserter Control Panel Icons	1-8
Change the Display Language	1-10

Chapter 2: Program a Job

Program a Job	2-5
Setup Mode	2-5
Select the Job Number (New or Existing Job)	2-5
Program a Scanning Job	2-6
Program a Non-Scanning Job	2-14
Modify an Existing Job	2-22
Delete a Job	2-22

Chapter 3: Run a Job

Run a Job	3-3
Verify the Inserter Has Power	3-4
Select a Job	3-4
Manual Feed Jobs	3-5
Load Material	3-6
Adjust and Load the Sheet Feeder	3-6
Adjust and Load the Envelope Feeder	3-7
Adjust and Load the Insert Feeder	3-8
Run a Trial Piece	3-10
Material Changes or Double Detect Issues	3-10
Start and Stop the Inserter	3-11
Fill the Sealer	3-11
Adjust the Stacker	3-12

Table of Contents

Chapter 4: OMR Scanning

Optical Mark Recognition (OMR).....	4-3
Accuracy	4-3
OMR and Feeders on the Inserter.....	4-3
OMR Scanning Types.....	4-4
Basic OMR.....	4-4
Enhanced OMR	4-4
OMR Mark Positions.....	4-4
OMR Specifications.....	4-5
Standard OMR Positions	4-6
Offset OMR Positions.....	4-7
Available OMR Marks	4-8
Benchmark.....	4-8
Safety.....	4-8
End-of-Collation (EOC).....	4-8
Beginning-of-Collation (BOC)	4-8
Parity.....	4-8
Re-timing Mark.....	4-8
Select Feed (SF1, SF2).....	4-9
Auto Batch	4-9
Wrap Around Sequence (WAS1, WAS2, WAS3)	4-9
OMR Mark Grouping	4-10
C-Fold and Double-Fold Jobs	4-10
Adjust the OMR Scanner.....	4-11
OMR Troubleshooting.....	4-12
Error Recovery for OMR Jobs.....	4-12
Error Recovery for Accumulation Jobs.....	4-12
Error Recovery for Empty Feeders	4-12
OMR Error Messages.....	4-13

Chapter 5: Clear Material

Clear Material	5-3
Access Areas of the Inserter for Jam Removal	5-3
Sheet Feeders Tray - Remove and Replace.....	5-3
Fold Plates - Remove and Replace	5-4
Insert Tray - Remove and Replace	5-4
Access the Carriage Assembly	5-4
Access to Envelope Feeder Area.....	5-5
Access the Envelope Exit Area	5-5
Access the Envelope Inserting/Sealing Area	5-6
Access to the Sheet Feed Area	5-6

Chapter 6: Troubleshooting and Error Messages

General Troubleshooting	6-3
Error Messages	6-7

Chapter 7: Material Specifications

Material Specifications.....	7-3
Sheet Feeders	7-3
Insert Feeder.....	7-5
Sealer.....	7-5
Stacker.....	7-5
Material Requirements.....	7-5
Envelope Feeder.....	7-6
Inserter Specifications	7-8

This page is intentionally blank.

Safety

Follow these precautions whenever you use your inserting system:

- Read all instructions before you attempt to operate the system.
- Use this equipment only for its intended purpose.
- Place the system close to an easily accessible wall outlet.
- Place the system in an accessible location to allow for proper venting of the equipment and to facilitate servicing.
- Use the AC power adapter included with this device. Third party adapters may damage the device.
- Plug the AC adapter directly into a properly grounded wall outlet located near the equipment and easily accessible. Failure to properly ground the machine can result in severe personal injury and/or fire.
- The AC adapter/power cord is the primary means to disconnect this device from the AC supply.
- DO NOT use a wall outlet controlled by a wall switch or one that is shared with other equipment.
- DO NOT use an adapter plug on the line cord or wall outlet.
- DO NOT remove the ground pin from the line cord.
- DO NOT route the AC adapter power cord over sharp edges or trap it between furniture. Make sure there is no strain on the power cord.
- If the unit becomes damaged, unplug it from the wall.
- Keep fingers, long hair, jewelry and loose clothing away from moving parts at all times.
- Avoid touching moving parts or materials while the machine is in use. Before clearing a jam, be sure machine mechanisms come to a complete stop.
- Remove jammed material gently and carefully.
- DO NOT remove covers. Covers enclose hazardous parts that should only be accessed by properly trained service personnel.
- DO NOT place lighted candles, cigarettes, cigars, etc., on the system.
- To prevent overheating, do not cover vent openings.
- Use only approved supplies.
- Improper storage and use of aerosol dusters or flammable aerosol dusters can cause an explosive-like condition that could result in personal injury and/or property damage.
- Never use aerosol dusters labeled flammable and always read instructions and safety precautions on the duster container label.

Safety

- Operation of this equipment without periodic maintenance will inhibit optimum operating performance and could cause the equipment to malfunction.
- Always follow specific occupational safety and health standards for your workplace.
- To reduce the risk of fire or electrical shock, DO NOT attempt to remove covers or disassemble the control panel or its base. The cabinet encloses hazardous parts.
- Before operating the main inserting machine with this device, make sure the machine has been properly prepared and that any other personnel in the area are standing clear of the inserter.
- Immediately report to service any damaged or non-functioning components that renders the unit unsafe.
- Contact your system supplier for the following:
 - Supplies
 - Material Safety Data Sheets
 - If you should damage the unit
 - Required maintenance service schedule

If your Stacker has an AC Adapter:

- Use the AC power adapter included with this device. Third party adapters may damage the device
- To protect against electrical shock, plug the AC adapter power cord into a properly grounded wall outlet.
- DO NOT route the power cord for the AC adapter over sharp edges or trap it between it between pieces of furniture. Make sure there is no strain on the power cord.

IMPORTANT: Some of the inserter features and options covered in here may not be available on your inserter.

1 • *System Overview*

Contents

Relay 2000 Inserter Overview	1-3
Product Features	1-3
Relay 2000 Inserter Component Identification	1-4
Inserter Control Panel Identification	1-6
Inserter Control Panel Icons	1-8
Change the Control Panel Display Language	1-10

This page is intentionally blank.

Relay 2000 Inserter Overview

- The Relay 2000 inserter is a two-station inserter with one sheet feeder and one insert feeder.
- Jobs are programmed and run via the control screen built into the system.
- Processing speed varies depending on machine configuration.
- Your system may be equipped with OMR (Optical Mark Recognition) scanning, depending on the model you purchased.



Product Features

The Relay 2000 inserters with a control panel offer these features:

- Envelope seal/no seal option
- Fully automatic material separation on sheet feeders
- Fully automatic setting of fold plates
- Fully automatic envelope separation
- Fully automatic double document detection (when selected)
- Fold-only option (fold without insertion)
- Manually fed, semi-automatic insertion of single and multi-sheet collations
- Option of single fold, letter (C) fold, accordion (Z) fold or double fold
- Job recall facility
- Optical Mark Recognition (OMR) scanning

1 • System Overview

Relay 2000 Inserter Component Identification

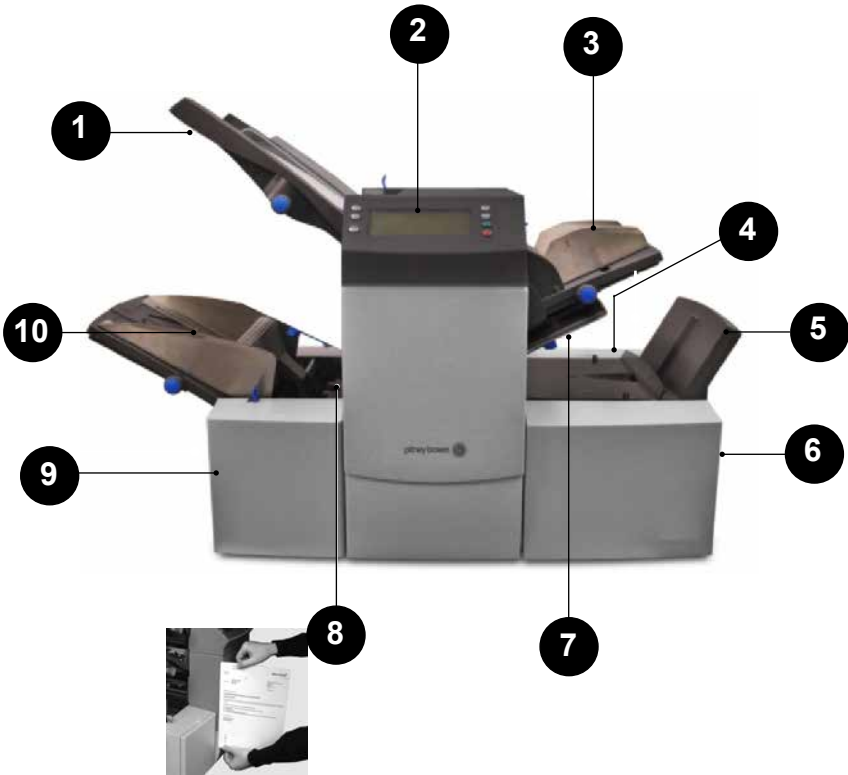

1	Sheet Feeder 1 - This feeder is intended for feeding material that requires folding. In addition, you can set sheet feeder 1 to Manual Feed . In this mode, you can run stapled sets of up to five sheets. The inserter waits for you to feed each set by hand into sheet feeder 1 before folding and inserting the set automatically.
2	Display/Control Panel - This is where you enter commands and where the inserter status is displayed through symbols and icons.

3	Insert Feeder - Use this feeder to add additional inserts to your envelope. Material fed from this feeder cannot be folded by the inserter. However, this feeder is especially suited to feeding pre-folded or thicker inserts.
4	Sealer Bottle - The sealer bottle is located on the rear of the inserter on the right side. It is under a hinged cover, labeled with the sealer icon. The sealer bottle provides sealing solution to the envelope sealer.
5	Envelope Inverter - Transports the envelope into the stacker <i>face up</i> .
6	Drop Stacker or Output Device (<i>not shown in image</i>) - Located at the exit of the inserter, this device collects finished mailpieces. This device can be latched against the inserter when not in use. Alternatively, a range of power stackers are available which offer greater capacity than the standard drop stacker.
7	Fold Plate - This creates the desired fold in material fed from the sheet feeder. The fold plate is automatically set from the control panel.
8	Measuring Scale - The scale is located on the left side of the inserter near the sheet feeders; used as an aid in measuring material and envelopes.
9	Manual Advance Knob - The knob is located inside a cover at the lower center of the inserter. Use it to turn the inserter mechanisms by hand to help clear a material.
10	Envelope Feeder - Feeds envelopes into the inserting area where they are filled with material requested from the other feeder(s).

1 • System Overview

Inserters Control Panel Identification

Use the buttons on the inserter control panel to set up and run jobs. The display screen also shows system status.

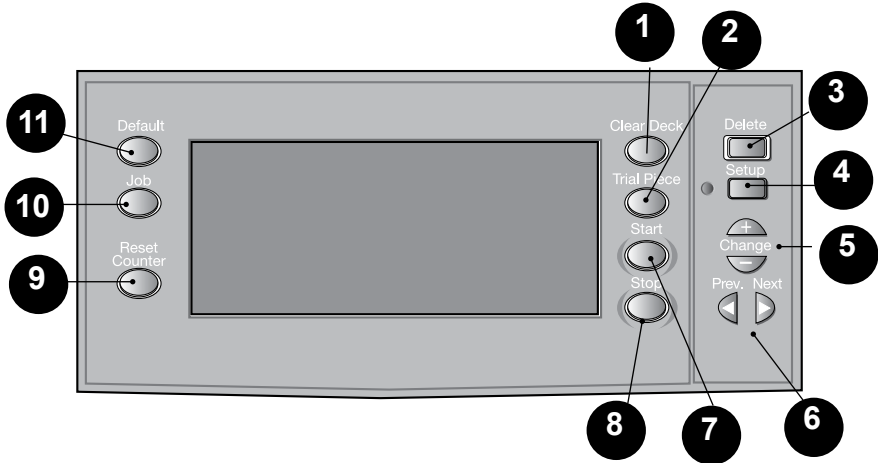











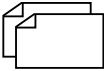

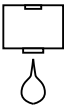

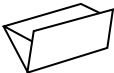

1	Clear Deck - Press to jog material through and out of the inserter. Also use it to clear the inserter and make it ready for automatic operation after a stoppage has occurred.
2	Trial Piece - Press to run a single test piece to check inserter setup. You must run a trial piece before you begin automatic operation using the Start button. If double detection is enabled, the inserter sets itself automatically to run the trial piece. The trial piece envelope will be unsealed and counted as one item.
3	Delete - Press while in setup mode to delete a programmed job from memory.
4	Setup - Press to enter the setup mode. This mode allows you to program jobs into memory for instant recall using the Job button.
5	Change + - - In setup mode, press to select options or set values of inserter settings.
6	Prev ◀ ▶ Next - In setup mode, press to step backward or forward through the various job settings.

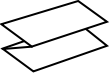
7	Start - Press to start automatic operation.
8	Stop - Press to stop automatic operation at the end of the next cycle.
9	Reset Counter - Press to reset the item or batch counter.
10	Job - Press to scroll through the jobs programmed in the inserter's memory. You can program up to 20 jobs in the inserter.
11	Default - Press to return the inserter to its default or standard settings. These settings come pre-configured from the factory, but a Pitney Bowes Service Representative can modify for your specific application.

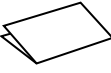
1 • System Overview

Insertion Control Panel Icons

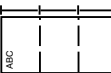
	Used on sheet feeders to signify that the feeder is on without double detection.
	Used on sheet feeders to signify that the feeder is on with double detection.
	Used on insert feeder to signify that the feeder is on without double detection.
	Used on insert feeder to signify that the feeder is on with double detection.
	Used on sheet feeder 1 to signify that the feeder is set for manual feed.
	Used on envelope feeder to signify that the feeder is on.
. . 3 . .	Indicates the setting (from 1 to 5) of the envelope stop.
	Indicates that the sealer bottle needs refilling.
	Indicates the envelope depth.
	Indicates the sealer unit is off (envelopes not sealed).
	Indicates the sealer unit is on (automatic envelope sealing)
	Indicates a C (letter) fold is selected

	Indicates a Z (accordion fold) is selected
	Indicates a double fold is selected
	Indicates a single fold is selected
	Indicates a no-fold insert operation
	Indicates a material stoppage. The position of this symbol in the display indicates where the stoppage has occurred.
	Call Pitney Bowes for service
	Indicates the paper size, address orientation and fold(s) set for sheet feeder
	Indicates a material stoppage in a downstream device, such as a power stacker.

1 • System Overview

Change the Control Panel Display Language

If you need the control panel to display a language other than English, you need to change the control panel to display the required language.

To change the language on the control panel display:

1. Open the cover to the right of the control panel display to access the setup buttons.
2. Press **Setup**. The inserter prompts for an access code.
3. Press **Change (+/-)** to increase or decrease to access code **99**.
4. Press **Next (▶)** to select the languages option.
5. Press **Change (+/-)** to scroll through the available languages.
6. When the desired language displays, press **Setup** to select the language and exit setup mode.

2 • *Program a Job*

Contents

Navigate Using the Control Panel.....	2-3
Scanning and Non-Scanning Jobs.....	2-4
Program a Job	2-5
Setup Mode.....	2-5
Select the Job Number (New or Existing Job).....	2-5
Program a Scanning Job	2-6
Program a Non-Scanning Job.....	2-14
Modify an Existing Job	2-22
Delete a Job.....	2-22

This page is intentionally blank.

This section provides step-by-step instructions for setting up and saving a new scanning or non-scanning job using the control panel. Programming a job is typically a Supervisor activity.

Navigate Using the Control Panel

Open the hinged cover to the right of the control panel display to access the setup buttons. Use the setup buttons to navigate the job programming options. To help visually guide you through the programming sequence, an asterisk (*) flashes on the control panel display next to the area being set.

- To access the setup buttons, open the hinged cover to the right of the display screen.
- Use the **Prev** (◀) and **Next** (▶) buttons to scroll through the available settings.
- Once the desired setting displays, use the **Change** (+/-) buttons to select options or set values within the settings.

2 • Program a Job

Scanning and Non-Scanning Jobs

If OMR scanning functionality is enabled on your system, operators can turn scanning on and off depending on the job. If scanning functionality is not available on your inserter, your job setup will differ slightly.

Refer to the table below to review the steps that apply to your job type and follow the step-by-step instructions provide in this section.

Scanning and Non-Scanning Job Sequence

Scanning Jobs	Non-Scanning Jobs
Enable scanning (OMR On or Off)	Disable scanning (OMR Off) if available on your inserter. (<i>Skip if you inserter does not have scanning</i>)
Set fold type	Set fold type
Set main (scanning) sheet feeder	Set accumulation
Set the sealer	Set sheet feeder 1
Set paper length	Set insert feeder
Set fold A /fold B	Set mode type (insertion or fold)
Set envelope depth	Set the sealer
Set envelope stop	Set paper length
Set batch counter	Set fold A /fold B
Confirm job setup	Set envelope depth
Run a trial piece	Set envelope stop
	Set batch counter
	Confirm job setup
	Run a trial piece

Program a Job

Setup Mode

1. Open the hinged cover to the right of the display to access the setup buttons.
2. Press **Setup**. The inserter prompts for an access code. (*This code prevents unauthorized personnel from changing inserter settings.*)
3. Press **Change (+/-)** to increase or decrease to access code **71**.
4. Press **Next (▶)** to accept the code and advance to the next job setting.

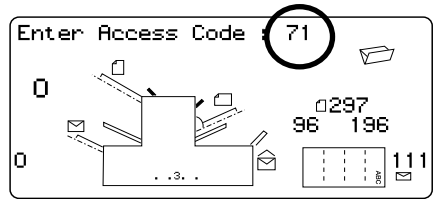

Select the Job Number (New or Existing Job)

When prompted for the job number, follow these steps to select or create the job. You can select an existing job and overwrite its current settings or you can select an unused job and program new settings.

1. Press **Change (+/-)** to scroll through the job numbers until you find the desired job number. (*To identify an unused job, scroll through the jobs until there are no setup symbols displayed on the screen.*)
2. Press **Next (▶)** to accept the job number and advance to the first setting.

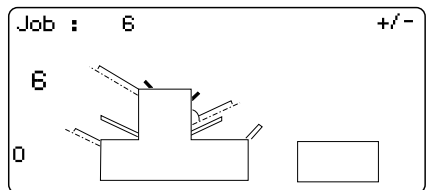

NOTE: If you use an existing job number, the old settings will be overwritten by the new settings you are adding.

2 • Program a Job

Program a Scanning Job

Enable OMR Scanning

1. When prompted, press **Change (+/-)** to select an **OMR on** settings.
(Refer to the OMR Settings table included here.)
2. Press **Next (▶)** to accept the selection and advance to the next setting.

OMR Scanning Settings Table

Use the OMR functions that apply to your scanning job.

OMR Settings Table

OMR Settings	Description
OMR off	OMR scanning is turned off for this job
OMR on	OMR scanning is enabled for this job with <i>standard</i> OMR mark positioning.
OMR + Sequence	OMR scanning + Wrap Around Sequence scanning is enabled for this job, with <i>standard</i> OMR mark positioning.
OMR + Select feed	OMR scanning + Select Feed/Autobatch scanning for this job, with <i>standard</i> OMR mark positioning.
OMR + Select feed + Sequence	OMR scanning + Select Feed/Autobatch + Wrap Around Sequence scanning is enabled for this job, with <i>standard</i> OMR mark positioning.
OMR Offset on	OMR scanning is turned on for this job, with <i>offset</i> OMR mark positioning.
OMR Offset + Sequence	OMR scanning + Wrap Around Sequence scanning is enabled for this job, with <i>offset</i> OMR mark positioning.
OMR Offset + Select feed	OMR scanning + Select Feed/Autobatch scanning is enabled for this job, with <i>offset</i> OMR mark positioning.
OMR Offset + SF + Sequence	OMR scanning + Select Feed/Autobatch + Wrap Around Sequence scanning for this job, with <i>offset</i> OMR mark positioning.

NOTE: Available options depend on the scanning functionality of your inserter.

Set the Fold Type

1. Press **Change (+/-)** to scroll through the fold types.
2. Press **Next (▶)** to accept the fold type selection and advance to the next setting.

Fold Types

C - Letter

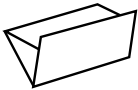

Double

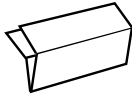

Only fold types C and double are available when using OMR scanning. When the fold type is selected, the display indicates the correct orientation of the paper for loading into the feeders:

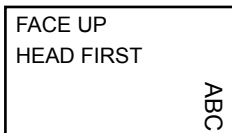



2 • Program a Job

Set the Main (Scanning) Sheet Feeder

1. Press **Change (+/-)** to scroll through the options.
2. Press **Next (▶)** to accept the option and advance to the next setting.

Main (Scanning) Sheet Feeder Options (Scanning Jobs)



Icon	Option	Description
	On Double Detect	Feeder on with the double detector operating. (The double detector stops the inserter if two or more sheets feed simultaneously.)
	On	Feeder on without the double detector.

Set the Insert Feeder

Select feed allows for one piece to be *selectively* fed from the insert feeder (this is controlled by the OMR marks) and inserted into the envelope.

1. Press **Change (+/-)** to scroll through the options. (Refer to the *Additional Feeder Options, Scanning Jobs* table for details.)
2. Press **Next (▶)** to accept the selection and advance to the next setting.

Additional Feeder Options (Scanning Jobs)

Icon	Option	Description
	On Double Detect - <i>can be selected with or without SF (Selective Feed)</i>	Feeder on with the double detect operating. (<i>Double detect stops the inserter if two or more sheets feed simultaneously.</i>)
	On without Double Detect - <i>can be selected with or without SF (Selective Feed)</i>	Select feeder on without the double detector.
	Off	Feeder turned off for this job.



2 • Program a Job

Set the Sealer

This setting appears only if *insertion mode is selected*. To select whether or not you want to seal envelopes.

1. Press **Change (+/-)** to toggle the option to **On** or **Off**.
2. Press **Next (▶)** to accept the option and advance to the next setting.

Sealer Options

Icon	Option	Description
	On	Turns the sealer unit on for automatic sealing of envelopes. Make sure the sealer water bottle is full of E-Z Seal® or water.
	Off	Turns the sealer unit off. Envelopes will be ejected unsealed.

Set Paper Length

1. Use the scale on the side of the inserter cover to measure the paper.
 - US letter - 279mm (11 inches)
 - A4 paper - 297mm
2. Press **Change (+/-)** to scroll through paper lengths (displayed in mm).
3. Press **Next (▶)** to accept the paper length value and advance to the next setting.



Set Fold A

1. Select the size of the first fold required.

NOTE: Depending on the settings you made earlier for fold type and paper length, the inserter suggests the correct dimension for the first fold. Most of the time this setting will prove satisfactory.

2. To change the standard fold setting, press **Change (+/-)** until the length of required fold displays. The symbol | ——— | displays next to the fold panel you are setting.

NOTE: The inserter automatically limits your options to available specifications on your inserter. (As you change the length of fold A, the dimension of fold B changes automatically to keep within the correct paper length and inserter specifications.)

3. Press **Next (▶)** to accept the fold value and advance to the next setting.

Set Fold B

1. Select the size of the second fold required.

NOTE: Like fold A, the inserter suggests the correct dimension for fold B.

2. To change the standard setting, press **Change (+/-)** until the length of fold required displays. The symbol | ——— | displays next to the fold panel you are setting.
3. Press **Next (▶)** to accept the fold value and advance to the next setting.

Set Envelope Depth

1. Use the scale on the front cover to measure the envelope depth.
2. Press **Change (+/-)** to scroll through the measurements (displayed in mm).
3. Press **Next (▶)** to accept the value and advance to the next setting.

2 • Program a Job

Set the Envelope Stop

NOTE: The stop has five positions numbered 1 to 5. Setting 3 is the standard setting for normal weight paper with standard folds. A thinner/lighter insert requires a lower setting and a thicker/heavier insert requires a higher setting.

1. Press **Change (+/-)** to scroll through the envelope stop positions.
2. Press **Next (▶)** to accept the position and advance to the next setting.

Set the Batch Counter

The batch counter allows you to automatically process pre-defined batches of finished mailpieces. When the batch is complete, the inserter automatically stops.

*NOTE: If the batch counter is not turned on, the display counter simply counts the number of items processed until you press **Reset Counter**.*

1. Press **Start** to begin processing the next batch.
2. Press **Change (+/-)** to toggle the batch mode to **On** or **Off**.

*NOTE: If the **batch counter is turned on**, the inserter prompts for the batch quantity. The default quantity is 50, but you may select any value up to 999 by tapping the **Change (+/-)** icons.*

3. Press **Next (▶)** to accept the setting.

Confirm Job Setup

Job setup is now complete. Using the inserter model and icons, the touch screen display shows all the selected job settings.

1. Review the job settings.
2. Press **Prev (◀)** to scroll back and change a setting.
3. Press **Setup** to accept the new settings and exit setup mode.
4. When setup changes are complete, the touch screen displays the new job settings with the message *Trial Piece Required*.
5. Test the setup by running a trial piece.

NOTE: The inserter retains job settings until you change or delete them, even when the power is disconnected. If you need to change the name of the job, refer to "Change a Job Name" in the System Overview chapter of this guide.

Run a Trial Piece

Run a trial piece to test the job settings.

1. Load material and press **Trial Piece**.
2. If you need to make changes to the settings based on the trial piece:
 - a. Press **Setup**.
 - b. Log in with Supervisor access level.
 - c. Press **Prev (◀)**, **Next (▶)** to scroll to the setting you wish to modify.
 - d. Press **Change (+/-)** to scroll to the desired option.
3. Press **Setup** to accept the setting modification and return to run mode. The inserter saves the job with the new settings.
4. Run another trial piece to test the modified settings.

NOTE: Any time you modify settings you must run a trial piece.

Incorrect Address Position - Adjust Fold Settings

When you run a trial piece, if the address is not in the correct position refer to the *Adjust Fold Settings* table to help you fine tune your folds settings.

Adjust Fold Settings Table

Fold Type	Address Too Low	Address Too High
C - Letter Fold	Decrease Fold A	Increase Fold A and increase Fold B by the same amount.
Z - Accordion Fold	Increase Fold A	Decrease Fold A and increase Fold B by the same amount.
Single Fold	Increase Fold A	Decrease Fold A
Double Fold	Decrease Fold A	Increase Fold A

It is recommended the fold is only adjusted by 0.20 inches (5mm) each time.

2 • Program a Job

Program a Non-Scanning Job

Follow this sequence of steps to program a non-scanning job.

NOTE: If scanning is not available on your system, begin with "Set Accumulation."

Disable OMR Scanning if Functionality Exists

If scanning is enabled on your system, set it to OMR off.

1. When prompted, press **Change (+/-)** to select **OMR off**.
2. Press **Next (▶)** to accept the selection and advance to the next setting.

Set the Fold Type

1. Press **Change (+/-)** to scroll through the fold types.
2. Press **Next (▶)** to accept the fold type and advance to the next setting.

Fold Types

C - Letter

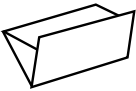

Z - Accordion

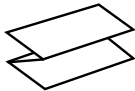

Double

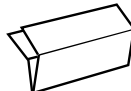

Single



When the fold type is selected, the display indicates the correct orientation of the paper for loading into the feeders:

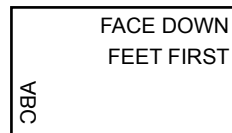
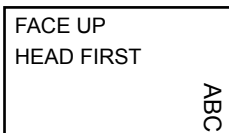

NOTE: For accumulation jobs, DO NOT manually change the automatic fold length dimensions at the Fold A and Fold B settings.

Set Accumulation

If *accumulation* is enabled, it allows multiple sheets to be fed from the sheet feeder into the envelope. *This setting is only available for non-scanning jobs.*

1. Press **Change (+/-)** to scroll through the accumulation options.
2. If you set accumulation to **ON**:
 - a. Press **Next (▶)** to set the number of pages to feed into each envelope. (**Accumulation = 2 to 10**)
 - b. Press **Change (+/-)** the to enter the number of pages.
3. Press **Next (▶)** to accept the option and advance to the next setting.

Inserter Accumulation Settings

Setting	Description
Accumulation: OFF	Accumulation is turned off for this job.
Accumulation: ON	Accumulation is turned on for this job.
Accumulation = (2 to 10)	If Accumulation is ON, select how many pages you want to feed into each envelope



IMPORTANT! *The number of sheets that can be accumulated is limited by inserter specifications. Exceeding this limit can cause a malfunction.*

2 • Program a Job

Set Sheet Feeder

1. Press **Change (+/-)** to scroll through the options.
2. Press **Next (▶)** to accept the selection and advance to the next setting.

First/Main Sheet Feeder Options (Non-Scanning Jobs)

Icon	Option	Description
	On Double Detect	Feeder on with the double detector operating. <i>(The double detector stops the inserter if two or more sheets feed simultaneously.)</i>
	Off	Feeder turned off for this job.
	On	Feeder on without the double detector.
	Manual Feed <i>(see the description following this table)</i>	Able to manually feed collated sets. Only available on sheet feeder 1.

Manual Feed Option



- The manual feed setting allows you to run stapled sets of up to five sheets - a maximum of 100 lbs.(400 gsm) per set. The maximum compressed thickness of the set *after folding* must not exceed 0.08 inches (2mm).
- The inserter waits for manual insertion of each set into sheet feeder 1 after which it will fold and insert the set automatically.
- The manual feed option is only available when Accumulation is set to OFF.

Set the Insert Feeder

Select whether you want to use the insert feeder and how it will be used.

1. Press **Change (+/-)** to scroll through the options. (Refer to the *Insert Feeder Options* table for descriptions.)
2. Press **Next (▶)** to accept the option and advance to the next setting.

Insert Feeder Options

Icon	Option	Description
	On Double Detect	Feeder on with the double detector operating. <i>(The double detector stops the inserter if two or more sheets feed simultaneously.)</i>
	On	Feeder on without the double detector.
	Off	Feeder turned off for this job.

Set the Mode Type - Insertion or Fold-Only

This setting only appears if *Accumulation* is *not turned on*.

The inserter needs to know if the job requires inserting material into an envelope or if it is a fold-only job.

To set the mode type:

1. Press **Change (+/-)** to toggle between the options.
 - **Insertion Mode**
Activates the envelope feeder for a normal inserting job.
 - **Fold-Only Mode**
Turns the envelope feeder off and sets the inserter to act as a folding module.
2. Press **Next (▶)** to accept the mode type and advance to the next setting.



2 • Program a Job

Set the Sealer

This setting appears only if *insertion mode is selected*. To select whether or not you want to seal envelopes:

1. Press **Change (+/-)** to toggle the option to **On** or **Off**.
2. Press **Next (▶)** to accept the option and advance to the next setting.

Sealer Options

Icon	Option	Description
	On	Turns the sealer unit on for automatic sealing of envelopes. Make sure the sealer water bottle is full of E-Z Seal® or water.
	Off	Turns the sealer unit off. Envelopes will be ejected unsealed.

Set Paper Length

1. Use the scale on the side of the inserter cover to measure the paper.
 - US letter - 279mm (11 inches)
 - A4 paper - 297mm
2. Press **Change (+/-)** to scroll through paper lengths (displayed in mm).
3. Press **Next (▶)** to accept the paper length value and advance to the next setting.



Set Fold A

1. Select the size of the first fold required.

NOTE: Depending on the settings you made earlier for fold type and paper length, the inserter suggests the correct dimension for the first fold. Most of the time this setting will prove satisfactory.

2. To change the standard fold setting, press **Change (+/-)** until the length of required fold displays. The symbol | ——— | displays next to the fold panel you are setting.

NOTE: The inserter automatically limits your options to available specifications on your inserter. (As you change the length of fold A, the dimension of fold B changes automatically to keep within the correct paper length and inserter specifications.)

3. Press **Next (▶)** to accept the fold value and advance to the next setting.

Set Fold B

1. Select the size of the second fold required.

NOTE: Like fold A, the inserter suggests the correct dimension for fold B.

2. To change the standard setting, press **Change (+/-)** until the length of fold required displays. The symbol | ——— | displays next to the fold panel you are setting.
3. Press **Next (▶)** to accept the fold value and advance to the next setting.
 - **Inserting jobs** - continue to the *Set the Envelope Depth* setting.
 - **Fold-only job** - there are no more job settings, skip to *Confirming the Job Setup*.

Set Envelope Depth

1. Use the scale on the front cover to measure the envelope depth.
2. Press **Change (+/-)** to scroll through the measurements (displayed in mm).
3. Press **Next (▶)** to accept the value and advance to the next setting.

2 • Program a Job

Set the Envelope Stop

NOTE: The stop has five positions numbered 1 to 5. Setting 3 is the standard setting for normal weight paper with standard folds. A thinner/lighter insert requires a lower setting and a thicker/heavier insert requires a higher setting.

1. Press **Change (+/-)** to scroll through the envelope stop positions.
2. Press **Next (▶)** to accept the position and advance to the next setting.

Set the Batch Counter

The batch counter allows you to automatically process pre-defined batches of finished mailpieces. When the batch is complete, the inserter automatically stops.

*NOTE: If the batch counter is not turned on, the display counter simply counts the number of items processed until you press **Reset Counter**.*

1. Press **Start** to begin processing the next batch.
2. Press **Change (+/-)** to toggle the batch mode to **On** or **Off**.

*NOTE: If the **batch counter is turned on**, the inserter prompts for the batch quantity. The default quantity is 50, but you may select any value up to 999 by pressing **Change (+/-)**.*

3. Press **Next (▶)** to accept the setting.

Confirm Job Setup

Job setup is now complete. Using the inserter model and icons, the touch screen display shows all the selected job settings.

1. Review the job settings.
2. Press **Prev (◀)** to scroll back and change a setting.
3. Press **Setup** to accept the new settings and exit setup mode.
4. When setup changes are complete, the touch screen displays the new job settings with the message *Trial Piece Required*.
5. Test the setup by running a trial piece.

NOTE: The inserter retains job settings until you change or delete them, even when the power is disconnected. If you need to change the name of the job, refer to “Change a Job Name” in the System Overview chapter of this guide.

Run a Trial Piece

Run a trial piece to test the job settings.

1. Load material and press **Trial Piece**.
2. If you need to make changes to the settings based on the trial piece:
 - a. Press **Setup**.
 - b. Log in with Supervisor access level.
 - c. Press **Prev** (◀), **Next** (▶) to scroll to the setting you wish to modify.
 - d. Press **Change** (+/-) to scroll to the desired option.
3. Press **Setup** to accept the setting modification and return to run mode. The inserter saves the job with the new settings.
4. Run another trial piece to test the modified settings.

NOTE: Any time you modify settings you must run a trial piece.

Incorrect Address Position - Adjust Fold Settings

When you run a trial piece, if the address is not in the correct position refer to the *Adjust Fold Settings* table to help you fine tune your folds settings.

Adjust Fold Settings Table

Fold Type	Address Too Low	Address Too High
C - Letter Fold	Decrease Fold A	Increase Fold A and increase Fold B by the same amount.
Z - Accordion Fold	Increase Fold A	Decrease Fold A and increase Fold B by the same amount.
Single Fold	Increase Fold A	Decrease Fold A
Double Fold	Decrease Fold A	Increase Fold A

It is recommended the fold is only adjusted by 0.20 inches (5mm) each time.

2 • Program a Job

Modify an Existing Job

To modify an existing job follow these steps. (This requires Supervisor level access.)

1. Press **Setup** to enter setup mode.
2. Press **Change (+/-)** to increase or decrease to access code **71**.
3. Press **Next (▶)** to accept the code and advance to the job selection.
4. Use **Change (+/-)** to display the job you wish to modify.
5. Press **Next (▶)** to accept the job selection and advance to the job programming settings.
6. Use **Prev (◀)** and **Next (▶)** to scroll through the settings.
7. When you find the desired setting, use **Change (+/-)** to scroll through the options and/or values you want.
8. Press **Next (▶)** to accept the job setting.
9. Press **Setup** to exit the setup mode and save the changes.

Delete a Job

To delete an existing job from the inserter system follow these steps. (This requires Supervisor level access.)

1. Press **Setup** to enter setup mode.
2. Press **Change (+/-)** to increase or decrease to access code **71**.
3. Press **Next (▶)** to accept the code and advance to the job selection.
4. Press **Change (+/-)** to display the job you wish to delete.
5. Press **Delete**. The display reads “Press again to confirm.”
6. Press **Delete** again. The display briefly reads “Deleting Job” as the job is erased.
7. Press **Setup** to exit the setup mode.

3 • *Run a Job*

Contents

Run a Job	3-3
Verify the Inserter Has Power.....	3-4
Select a Job.....	3-4
Manual Feed Jobs	3-5
Load Material.....	3-6
Adjust and Load the Sheet Feeder	3-6
Adjust and Load the Envelope Feeder.....	3-7
Adjust and Load the Insert Feeder.....	3-8
Run a Trial Piece	3-10
Material Changes or Double Detect Issues	3-10
Start and Stop the Inserter	3-11
Fill the Sealer.....	3-11
Adjust the Stacker	3-12

This page is intentionally blank.

Run a Job

The operating activities outlined here assume that a job has already been programmed into the Relay 2000 inserter. (*Programming a job is typically a Supervisor function.*)

Activities Operators perform with the touch screen to run a previously programmed job:

- Verify the inserter has power
- Select a job
- Load material
 - Adjust and load the sheet feeder
 - Adjust and load the envelope feeder
 - Adjust and load the insert feeder
- Run a trial piece
- Run the job
- Fill the sealer (*if needed*)
- Adjust the stacker (*if needed*)



Read the safety information in this guide *before* connecting the inserter.

3 • Run a Job

Verify the Inserter Has Power

1. Verify the power cord is connected to the socket on the back of the inserter.
2. Verify the power cord is plugged into a power outlet near the machine and is easily accessible.
3. Turn the power switch ON.



Select a Job

When the machine is turned ON, the control panel display shows the last job run and the message *Trial Piece Required*.

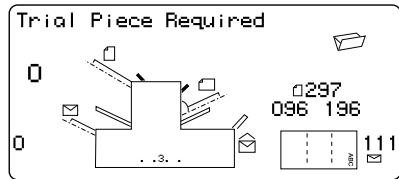

To select the job you wish to run:

1. Press the **Job** button until the job you want displays, *OR* press **Default** if you want to run the inserter with your standard, default job settings

NOTE: Only a PB Service Representative can modify default job settings.

2. Load material - refer to the *Loading Material* section.
3. If material is already loaded, press **Trial Piece**. The inserter sets itself and runs a test piece to check.

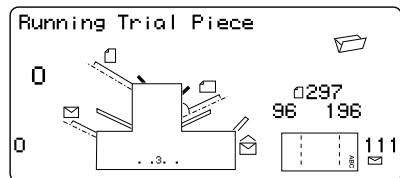

Manual Feed Jobs

If you select a manual feed job where sheet feeder 1 is set for manual feed of collated sets, DO NOT load the sheet feeder. Instead, you will feed collated sets one at a time, by hand, as required.

Before you run a manual feed job, pull back the lever (shown here).

This opens the feed mechanism for manual feed operation.

NOTE: Return this lever to its normal position when you use the feeder for automatic operation.

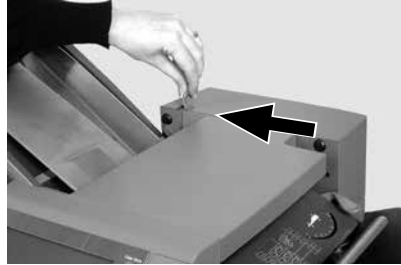

3 • Run a Job

Load Material

Adjust and Load the Sheet Feeder

1. Adjust the side guides to the *width* of the material, then back-off a quarter turn on the side guide control. This sets the correct clearance between the guides and the material.



2. Aerate (fan) the stack of paper to ensure that individual sheets are not stuck together.

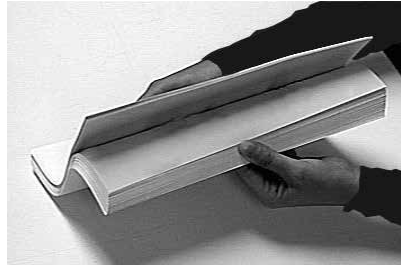

3. Jog stack back into alignment.

The display indicates the correct orientation of the paper.

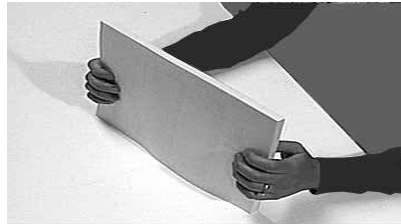

4. Place the paper stack onto the feed deck. Allow the deck to move down and the top of the paper stack to slide under the feed roller.



Adjust and Load the Envelope Feeder

The envelope feeder feeds the outer envelope for the inserting job.

1. Use the side guide adjustment knob to adjust the side guides to the *width* of the envelopes. Once adjusted, back-off the adjustment knob 1/4 turn.

This sets the correct clearance between the guides and envelopes.



2. Take the stack of envelopes; aerate and fan it to ensure that individual envelopes are not stuck together.

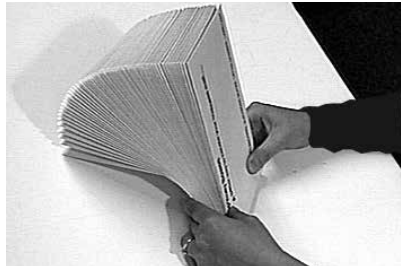

3. Place the envelopes on the feed deck with the flaps up and trailing.

IMPORTANT! Check that lead edge of the first envelope is under the front feed roller and that the stack of envelopes is shingled on the deck as shown.

4. Let the wedge slide down behind the stack so that the envelopes are supported.



3 • Run a Job

Adjust and Load the Insert Feeder

The insert feeder feeds items that do not require folding. Depending on configuration of your inserter, you may not have an insert feeder.

1. Use the side guide adjustment knob to adjust the side guides to the *width* of the inserts you are running. Once adjusted, back-off the adjustment knob 1/4 turn.

This sets the correct clearance between the guides and inserts.



2. Refer to the label located on the insert feeder and match your insert type with the icon (letters A to D).

Identifying Your Insert

If the label indicates a range of settings, we recommend you select a higher number or letter for a thicker the insert.

3. Set the blue lever to the **number** required.



4. Set the separator shield to the **letter** required.

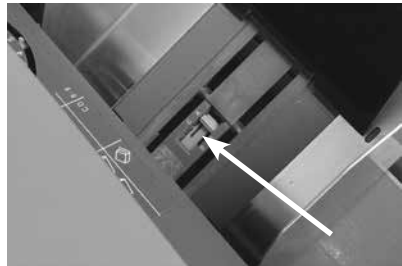

5. Aerate and fan the stack of inserts to ensure the individual pieces are not stuck together.

Loading orientation can vary depending on the inserts being run. As a general rule, load inserts using the orientation guidelines in the table below.

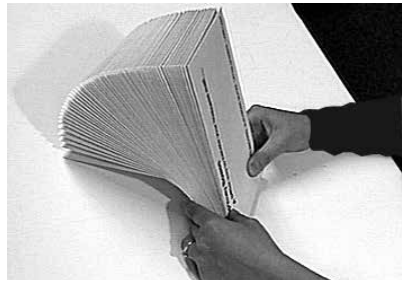

6. Let the wedge (material prop) slide down behind the stack to support the inserts.



Orientation Table for Loading Inserts

Insert Type	Orientation
Slip	Face up, bottom edge first
Reply Envelope	Face up, top edge first
Pre-Folded	Face up, closed edge first
Booklet	Face up, bound edge first

3 • Run a Job

Run a Trial Piece

Run a trial piece to test the job settings.

1. Load material and press the **Trial Piece** button on the control panel to run a trial piece and verify the job setup is correct.
2. You can still make changes to the job settings at this point if the trial piece needs fine tuning. (*This requires Supervisor level access.*)
 - a. Press the **Setup** button.
 - b. Log in at a Supervisor access level.
 - c. Use the **Prev** (◀), **Next** (▶) and **Change** (+/-) buttons to scroll through the settings and modify the one(s) you wish to change.
3. When you have made the necessary changes, press **Setup** again to return to run mode.
4. Run another trial piece to test the modified settings.

Material Changes or Double Detect Issues During Operation

If you load material during a job run with different characteristics (weight, color shade, etc.), *OR* if you have problems with the double detect, run another trial piece.

This causes the inserter to recalibrate the double detect function for the new material.

Start and Stop the Inserter

1. Press **Start** on the control to begin automatic operation.
2. The inserter runs until it runs out of material or you press the **Stop**.

Fill the Sealer

When the sealer unit needs refilling, the **Add Sealing Solution** icon flashes in the display.



When this happens, add E-Z Seal® Sealing Solution or water:

1. Open the sealer bottle cover hinge located at the rear, right side of the inserter and remove the bottle.
2. Fill the bottle with solution or water to the level indicated.
3. Place the sealer bottle in position in the inserter and close the cover.



NOTE: If the sealer unit was completely empty, allow time for the fresh solution or water to soak through the sealer before you resume operation. This helps assure a good seal.

NOTE: We recommend Pitney Bowes E-Z Seal to minimize algae growth and scale build-up.

3 • Run a Job

Adjust the Stacker

If necessary, adjust the drop stacker to accommodate the job material.

1. Lift the lever at the rear of the stacker and adjust the stacker to one of the preset positions.
2. Lower the lever to lock the stacker into position.

NOTE: When not in use, you can raise the stacker and latch it vertically against the exit area of the inserter.



4 • OMR Scanning

Contents

Optical Mark Recognition (OMR).....	4-3
Accuracy	4-3
OMR and Feeders on the Inserter.....	4-3
OMR Scanning Types.....	4-4
Basic OMR.....	4-4
Enhanced OMR	4-4
OMR Mark Positions.....	4-4
OMR Specifications	4-5
Standard OMR Positions	4-6
Offset OMR Positions.....	4-7
Available OMR Marks	4-8
Benchmark.....	4-8
Safety.....	4-8
End-of-Collation (EOC).....	4-8
Beginning-of-Collation (BOC)	4-8
Parity.....	4-8
Re-timing Mark.....	4-8
Select Feed (SF1, SF2)	4-9
Auto Batch	4-9
Wrap Around Sequence.....	4-9
OMR Mark Grouping	4-10
C-Fold and Double-Fold Jobs	4-10
Adjust the OMR Scanner.....	4-11
OMR Troubleshooting.....	4-12
Error Recovery for OMR Jobs.....	4-12
Error Recovery for Accumulation Jobs.....	4-12
Error Recovery for Empty Feeders	4-12
OMR Error Messages.....	4-13

This page is intentionally blank.

Optical Mark Recognition (OMR)

An OMR mark is normally a dark solid line on a sheet of light colored paper that is perpendicular to the direction of paper travel. This line must be thick and dense to trigger the OMR scanner.

The OMR scanner works with the OMR system software to check for one or more different OMR marks on a document as it is fed through the system. Tracking of these marks enhances mail piece integrity by assuring the documents that belong together (a set) stay together throughout the inserting process.

NOTE: Depending on the model, your inserter may be equipped with OMR scanning.

NOTE: For instructions on programing an OMR job, refer to the Programing a Job section of this manual.

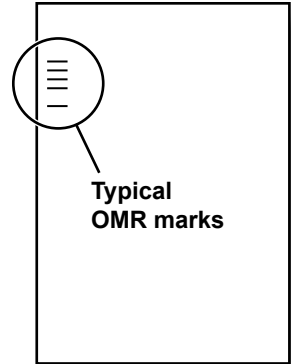

Accuracy

OMR on this system uses extensive error checking. This means insertion accuracy is very high: the probability of the wrong set of sheets being inserted into an envelope is low.

OMR and Feeders on the Inserter

OMR-equipped models have scanning heads on each sheet feeder.

The sheet feeder holds sheets with OMR marks and they feed multiple sheets per envelope and can handle C-folds and double folds.

You can set up only the insert feeder to be under the selective control of the OMR sheets. As a result, you can use OMR to fill an envelope with a variable number of sheets from one feeder, with or without a supplementary sheet and an insert.

A folded insert is nested with the first sheet in the envelope. Because OMR applications allows each envelope to contain tailored contents, the last sheet in the envelope includes address information for use with windowed envelopes. This ensures that each set of sheets is addressed to the correct recipient.

4 • OMR Scanning

OMR Scanning Types

Basic OMR

- Enables the collation of multi-page documents.
- Enables you to vary the number of pages per envelope.
- The inserter folds each OMR sheet separately and inserts it into an envelope, starting with the last sheet of the set and adding each folded sheet in turn until the address sheet has been inserted.

Enhanced OMR

- Allows you to stop feeding sheets at selected points in a run and/or select whether the other feeders are used.
- It provides a higher level of mailpiece integrity so that sensitive documents are not sent to the wrong customer.

OMR Mark Positions

For the inserter scanners to read the printed OMR marks correctly, they *must* be located within a defined range of positions on the page.

- **Standard** OMR positions *OR*
- **Offset** OMR positions allow the marks to be positioned further down the page.

OMR Specifications

The OMR mark must be a solid black line between 1pt and 2pts thick (0.014 inch (0.35mm) to 0.027 inch (0.7mm)) and at least 0.393 inch (10mm) wide.

Each mark position must be evenly spaced, at least 0.118 inch (3mm) apart.

The area around the marks (the clear zone) should be kept clear from print and any other marks that the scanner might read in error.

There should be no print on the opposing face of the sheet immediately behind the clear zone.

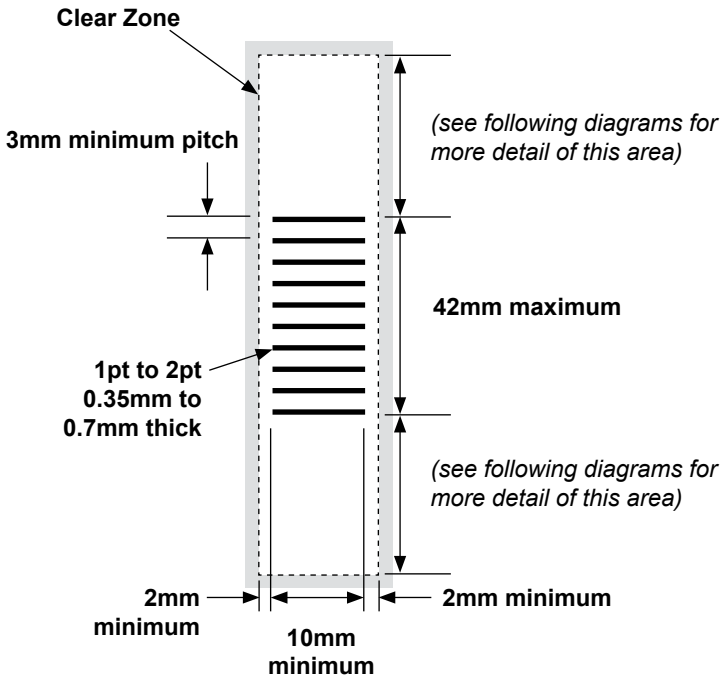

(Note: diagram is not to scale)

4 • OMR Scanning

Standard OMR Positions

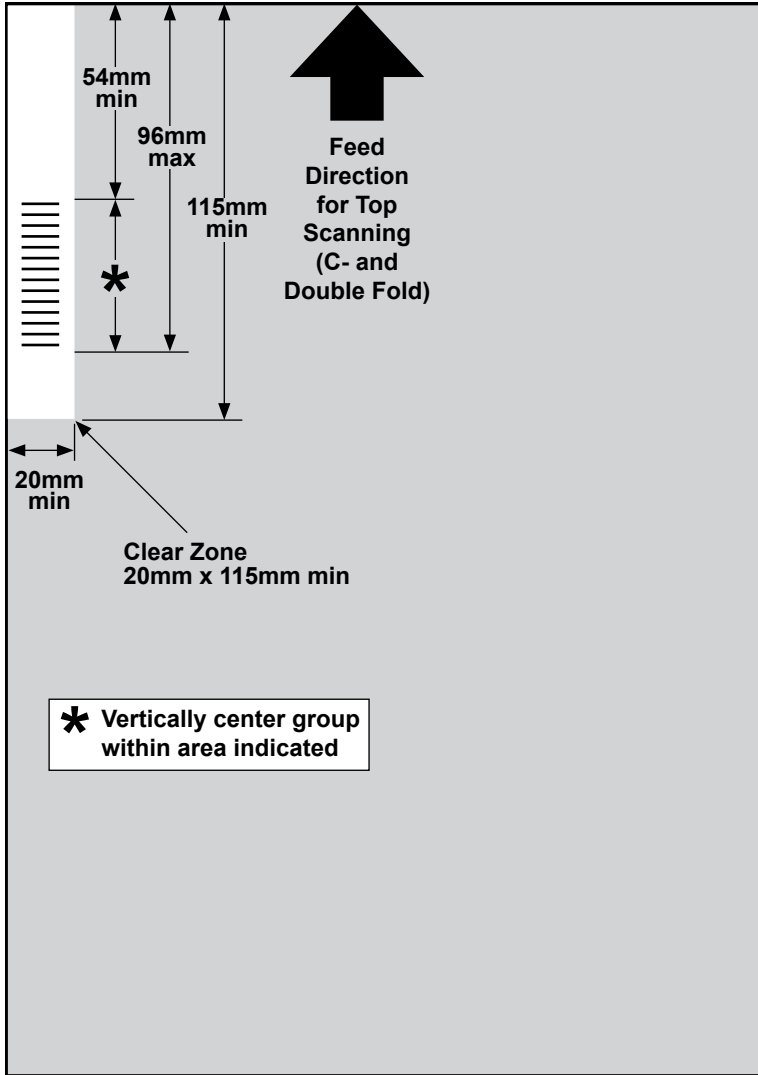

Position OMR marks as follows:

- C-Fold and Double Fold: top scanning, top left corner.

(diagram is not to scale)

Offset OMR Positions

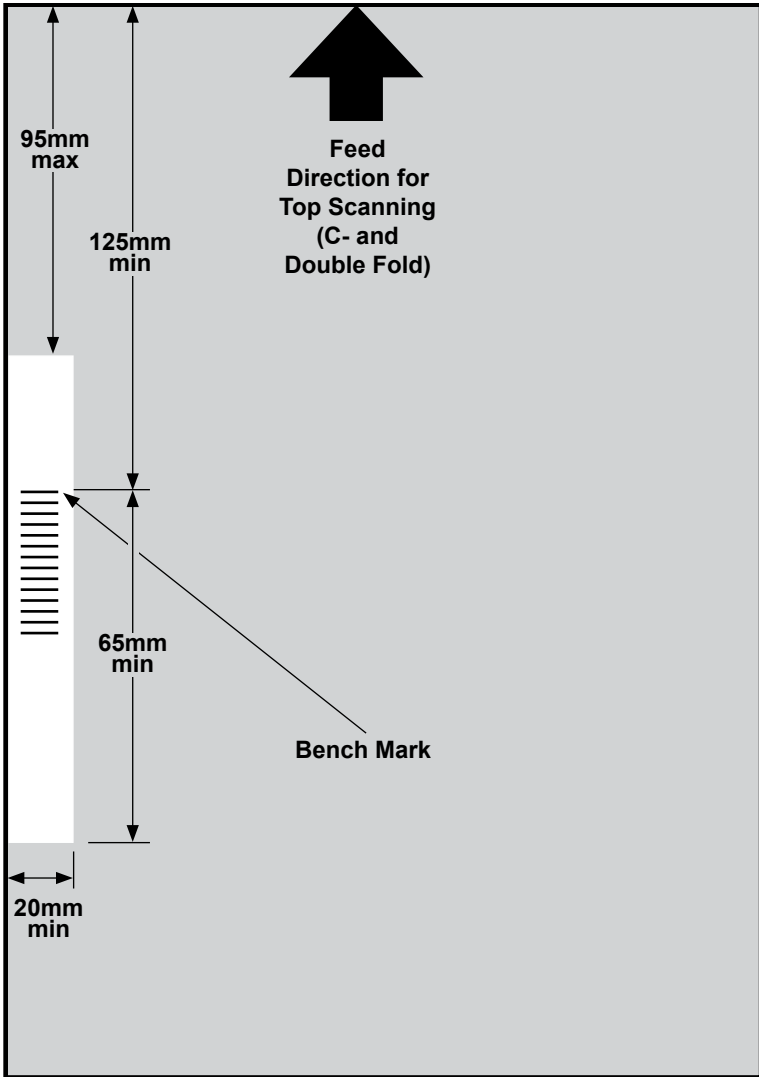

Position OMR marks as follows:

- C-Fold and Double Fold: top scanning, left margin.

(diagram is not to scale)

4 • OMR Scanning

Available OMR Marks

This section gives brief descriptions of the OMR marks that can or must be allocated to an OMR Code.

NOTE: Some marks within this section are available as added features that expand OMR capability. OMR features will vary depending on the options you purchased.

Benchmark

This is a mandatory mark. It must be the *first* mark of the code and will appear on *every* page within the set.

Safety

This is a mandatory mark that improves the integrity of your mail piece. It is automatically placed immediately after the benchmark.

End-of-Collation (EOC)

This mark indicates that this sheet is the *last sheet fed within the collation/set* (the address sheet).

Your system operates on the *absence* of this mark, that is, the action will take place if the mark is *not* read by the scanner. It is therefore indicated on the OMR code as **Not EOC**.

Beginning-of-Collation (BOC)

This mark indicates this sheet is the *first sheet fed within the collation/set*.

Your system operates on the *absence* of this mark, that is, the action will take place if the mark is *not* read by the scanner. It is therefore indicated on the OMR code as **Not BOC**.

Parity

This mark is a security feature that makes the number of marks total an even number when printed. If any one of the marks in the code is missed during scanning, the inserter stops so the operator can correct the error.

Re-timing Mark

This mark is mandatory in each group of OMR marks making up the code (see later in this section for an explanation of OMR mark grouping).

It allows the inserter to recalibrate for accurate scanning. Re-timing marks count in the parity calculation.

Select Feed (SF1, SF2)

These marks are used to control the feed of material from the feeder holding the supplementary inserts on a set-by-set basis.

Use **Select Feed 2** marks in the primary sheet feeder to select material from the insert feeder. For C- and double fold, the primary feeder is sheet feeder 1.

Auto Batch

This mark identifies the last set of a batch, when the batch function is in use. It must appear on all sheets of the OMR set that requests this function.

Wrap Around Sequence (WAS1, WAS2, WAS3)

This is a numbering system which uses a sequential binary coding. If a page is missing or the set goes out of sequential order, the system stops processing and declares an error.

Three wrap around sequence marks are used within the code. The use of three binary digits allows a decimal count of 0 to 7. Pages are numbered from 0 up to 7, and then back to 0 on a continuous cycle throughout the print run.

4 • OMR Scanning

OMR Mark Grouping

Each OMR code begins with two fixed marks: benchmark and safety mark. These marks are located at the end nearest to the sensor. These are followed by one, two, or three groups of marks where each group comprises three data marks followed by a fixed mark. Each data mark is present or absent as required to reflect the desired function. Each code must end with a re-timing mark.

The **Basic OMR** mode uses only Group 1. The **Enhanced OMR** mode uses Group 1 plus Group 2 and/or Group 3, as needed for a particular job.

C-Fold and Double-Fold Jobs

Place marks in the upper left corner of the sheet. Print marks in top-to-bottom order.

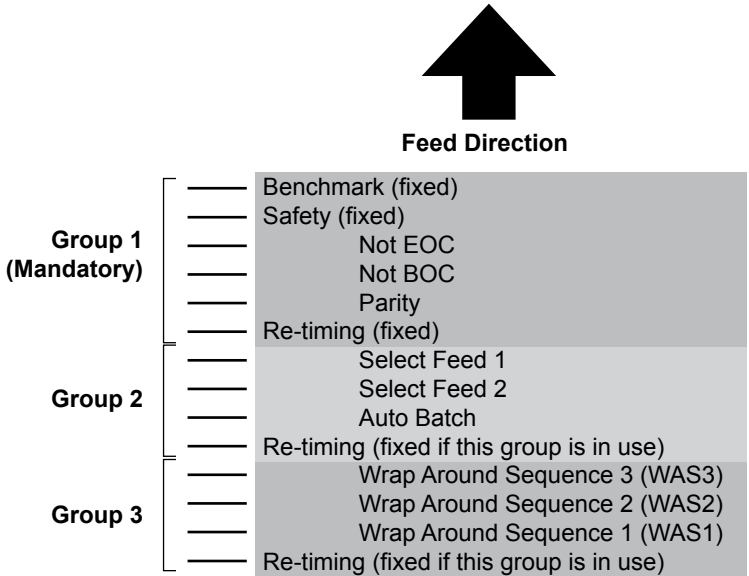

Printing

Print sheets in reverse collation order. When you do this, the last sheet processed in each set is the address sheet and the first sheet processed is the last of each set.

Adjust the OMR Scanner

In order for OMR scanning to work correctly, it is important to ensure that the scanning heads are positioned in line with the Scan Dash (OMR) marks printed on the material.

1. To locate the scanning head for sheet feeder 1, open the top cover. The scanning head is at the rear of the inserter.
2. Fold a sheet of material in half and measure the distance from the side of the sheet to the middle.
 - A4 size sheet = this measurement is 105mm
 - Letter size sheet = 8.5 x 11 inches (108mm)
3. Next, measure the distance from the edge of the sheet to the middle of the scan dash marks (as shown in the following example), and subtract this measurement from the half-fold measurement.

Folding Example:

For an A4 size sheet, the half fold measurement is **105mm**.

If the distance from the edge of the form to the middle of the scan dash marks is **10mm**, the scanning head setting will be **95mm** ($105\text{mm} - 10\text{mm}$).

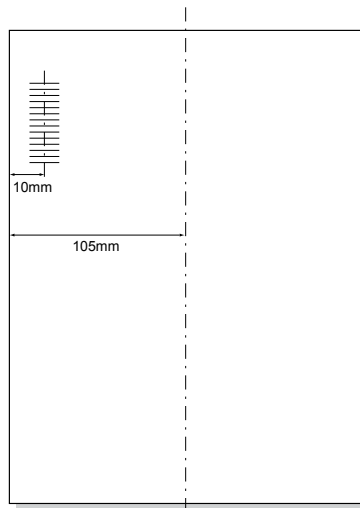

4. Loosen the locking knob and set the relevant scanning head to the correct setting.
5. Retighten the locking knob.

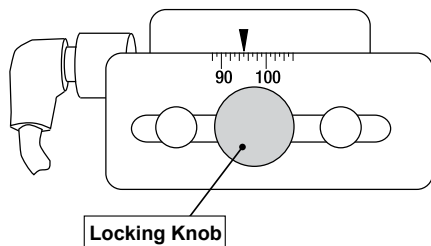

OMR Troubleshooting

Error Recovery for OMR Jobs

If the inserter stops during an OMR job, and indicates one of the error messages listed below, follow these steps.

1. Press the **Clear Deck** key on the control panel. Any envelope at the insertion area will eject into the stacker.
2. The remaining pages of the current set will feed/fold and eject into the stacker. Manually insert into the envelope if necessary.
3. The FIRST page of the NEXT set will pre-feed into the feed rollers and stop. Pull the sheet back to the normal feed position .
4. Resume operation.

Error Recovery for Accumulation Jobs

If the inserter stops during an accumulation job, follow these steps.

1. Press the **Clear Deck** key on the control panel
2. The envelope at the insertion area ejects into the stacker. You must manually remove the remaining pages of the set from the feeder.
3. Fold/insert the remaining pages into the envelope.
4. Resume operation once you've determined the cause of the stoppage.

Error Recovery for Empty Feeders

If any feeder runs out of material the inserter will stop, and the following instructions scroll across the display.

1. Re-fill the empty tray.
2. Press **START** to continue *OR* press **STOP** and **Clear Deck**.
3. Reload the feeders and proceed as required.

OMR Error Messages

Message	Action
Bad OMR marks Spacing	Two marks that are closer together than half the expected distance are read. Check scan marks on material.
No OMR marks	<ul style="list-style-type: none"> • No marks on paper. • Scan sensor is not centered over scan marks. • Paper not loaded correctly.
Bad OMR Code length	Code type on paper does not match the setup. <i>(Example: setup has OMR+ Sequence but paper has OMR + Select Feed + Sequence.)</i>
Bad OMR Code format	A re-timing scan mark is missing. Check material. <i>(Example: mark 6 missing from a 10 mark code.)</i>
Expected 1st Sheet of set	The BOC mark (position 4) was present when it was not expected. First page of the set was expected.
Not a new Envelope	The BOC mark (position 4) was absent when it was expected. Pages other than the first page of the set were expected.
OMR: Parity Error	The code doesn't have an even number of marks.
OMR: Sequence Error	The sequence number is not sequential with the previous page fed. Therefore, sheets are in the wrong order or missing.
OMR: SF marks Inconsistent	The Selective feed and Autobatch marks at positions 7 to 9 are different from those on the previous sheet of this set.
OMR: SF not in Use	A selective feed mark is present at positions 7 to 8, but the job setup does not include select feed.
OMR: Set too Large	The set contains too many sheets from the main feeder.
OMR: End of Batch Ready to Run	<ul style="list-style-type: none"> • Inserter has stopped for "End of Batch." • Allows the operator to manually sort envelopes.
Mode Change Recheck Feeders	Check sheet and insert feeder settings against the job you are loading before exiting the setup mode.

This page is intentionally blank.

5 • Clear Material

Contents

Clear Material	5-3
Access Areas of the Inserter for Jam Removal	5-3
Sheet Feeders Tray - Remove and Replace...	5-3
Fold Plates - Remove and Replace	5-4
Insert Tray - Remove and Replace	5-4
Access the Carriage Assembly	5-4
Access to Envelope Feeder Area.....	5-5
Access the Envelope Exit Area	5-5
Access the Envelope Inserting/Sealing Area ..	5-6
Access to the Sheet Feed Area	5-6

This page is intentionally blank.

Clear Material

The inserter is designed to assure maximum performance. In the event of a material stoppage, the display flashes a symbol indicating where the stoppage has occurred.

To clear a jam follow these steps.

1. Press **Clear Deck** to attempt to feed the material through the inserter.
2. If this doesn't work, manually remove the trays and fold plates related to the jam to gain access to the jammed material.

Manual Advance Knob

Once you locate the jammed material, you may need to use the manual advance knob to manually feed paper out of the grip of feed rollers.

The manual advance knob is located behind the drop-down cover at the left front of the inserter.



Access Areas of the Inserter for Jam Removal

Sheet Feeders Tray - Remove and Replace

To **remove** the sheet feeder tray:

1. Lift the rear of the tray slightly and pull it straight out from the inserter.

NOTE: If the tray is loaded, gently hold the material in place to prevent it sliding forward as the tray is removed.



To **replace** the sheet feeder tray:

1. Place the tray into its location guides in the side frames.
2. Lift the rear of the tray slightly and push it into the inserter. The tray automatically drops into its correct position.

5 • Clear Material

Fold Plates - Remove and Replace

To **remove** the fold plates:

1. Pull the two catches on the underside of the plate outward to release them.
2. Pull the plate straight out of the inserter.



To **replace** the fold plates:

1. Pull the two catches (on the underside of the plate) outward to release.
2. Slide the plate into its location guides and release the catches to lock the plate in position.

Insert Tray - Remove and Replace

To **remove** the insert tray, pull the insert tray straight out from the inserter.

To **replace** the insert tray, slide the tray into the location guides; push until it clicks into place.



Access the Carriage Assembly

Pull out the carriage assembly to access the jam.

1. Remove the insert feeder.
2. Remove fold plate 2.
3. Pull out the carriage assembly.



Access to Envelope Feeder Area

Unlatch the envelope area feed rollers to access a jam in the envelope feeder area.

1. Pull the release lever in the direction of the arrow.
2. Lift the envelope area feed rollers for access to the jam.

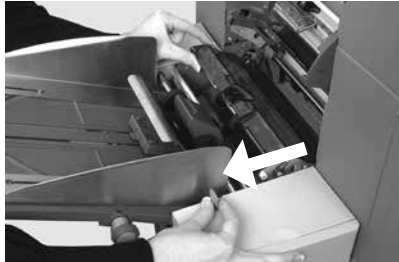

To **relatch** the feed rollers:

1. Release the envelope area feed rollers and let them rest in position
2. Push the rollers firmly down until they latch into position.

Access the Envelope Exit Area

1. Pull down the access door (shown here) to gain access to the jammed material.
2. When you close the access door, make sure to latch it firmly in position.



5 • Clear Material

Access the Envelope Inserting/Sealing Area

You can access the insertion and sealing area by lifting the tinted plastic cover and lowering the envelope inverter access door.

Access to the Sheet Feed Area

Unlatch the blue handles to access a jam in the sheet feeder area.

1. Open the top cover.
2. Squeeze the two blue handles together and pivot the guide assembly to the right to gain access to the jammed material.



To **relatch** the blue handles:

1. Squeeze the two blue handles together and pivot the guide assembly back to its closed position.
2. Release the two blue handles, making sure the assembly is securely latched into position.
3. Close the top cover.

6 • *Troubleshooting and Error Messages*

Contents

General Troubleshooting	6-3
Error Messages	6-7

This page is intentionally blank.

General Troubleshooting

<i>Issue</i>	<i>Possible Solutions</i>
INSERTER	
Blank Screen	
No power.	Check that the power cord is firmly connected and the wall socket is switched ON.
Inserter not switched ON.	Turn the power switch (located on left side) ON.
Inserter will not Operate	
Cover open.	Check that all covers are closed - check display for cover information.
Feed trays/fold plates not located correctly.	Remove and relocate all feeders and fold plates. Verify they are in the correct positions and fully seated.
Insertion Problems	
Outer envelope contents do not enter the envelope correctly.	Check the envelope troubleshooting information. Check that the fold selected is correct for the material size. If running heavy or light material, the envelope stop adjustment might need changing.

6 • Troubleshooting and Error Messages

Issue	Possible Solutions
ENVELOPES	
Poor Envelope Feed	
Envelope side guides set incorrectly.	Set the guides to the envelope width and then back off 1/4 turn.
Poor envelope quality.	Check that the envelopes are not curled. Try a new box of envelopes. Make sure to fan stack <i>before</i> loading.
Envelopes loaded incorrectly.	Load envelopes flap side up with the flap feeding last.
Envelopes Fail to Open	
Envelopes loaded incorrectly.	Load envelopes flap side up with the flap feeding last.
Poor envelope quality.	Check the envelopes are not stuck due to excessive dampness. Try a new box of envelopes.
Envelope Sealing Problems	
No sealing solution.	Refill the sealer unit.
Seal mode not selected.	<ul style="list-style-type: none">• Check job setup.• Activate sealing mode.
Poor sealing.	You may need to replace the sealing felts.

Troubleshooting and Error Messages • 6

Issue	Possible Solutions
SHEETS	
Poor Sheet Feed	
Feeder not selected to feed.	Check job setup.
Sheet feeder side guides set incorrectly.	Set guides to sheet width and back off 1/4 turn.
Sheets loaded incorrectly.	Make sure to fan stack <i>before</i> loading.
Multiple Sheets Feed when One Sheet is Expected	
Manual feed mode is selected.	Check job setup and manual feed lever position.
Sheets loaded incorrectly.	Make sure to fan stack <i>before</i> loading.
Address in Wrong Position in Envelope Window	
Address bearing sheets incorrectly loaded.	Load sheets so that the address appears through the envelope window.
Folds incorrectly set.	Check job setup.
Poor Folding	
A fold is <i>almost</i> corresponding with a perforation on the sheet, causing a box fold or third fold.	Adjust the fold sizes slightly to avoid this situation.

6 • Troubleshooting and Error Messages

<i>Issue</i>	<i>Possible Solutions</i>
INSERTS	
Poor Insert Feed	
Feeder not selected to feed.	Check job setup.
Insert feeder side guides set incorrectly.	Set guides to insert width and back off 1/4 turn.
Insert feeder separator adjustments incorrect.	Verify the two insert feeder adjustments (number and letter settings) are set correctly for the type of insert you're running.
Inserts loaded incorrectly.	Make sure to fan the stack before loading. It may help to change the orientation of the insert stack.
Insert feeder wedge used incorrectly.	Let the wedge slide down behind the insert stack to support it.
Inserts out of specification.	Check the specifications in this guide.

DOUBLE DETECT	
Inserter Stops for Doubles that Aren't There or Feeds Doubles without Stopping	
Double detect is not turned ON.	<ul style="list-style-type: none"> • Check double detect status. Double detect icon  appears alongside all items where the double detect is operational. • Correct loading or correct job setup as necessary.
Double detect is not correctly calibrated.	Run a trial piece whenever a new batch of material is loaded to recalibrate double detect. The new batch might be of slightly different thickness.

Error Messages

Message	Action
CALL SERVICE	Power the inserter off and on. If the message is still displayed, call service.
CHECK /CLEAR FEEDER	Feeder indicated has failed to feed material. Remove material from the feed tray, reload and restart the inserter.
CHECK FEEDER	Feeder indicated is not located correctly. <ul style="list-style-type: none">• Remove tray and relocate.• Also check loading of material in indicated feeder.
CHECK FOLD PLATE	Fold plate indicated is not located correctly. Remove fold plate and relocate.
CHECK INVERTER	Envelope inverter unit has not set to its correct position. <ul style="list-style-type: none">• Open the inverter cover and check for material.• Close the cover and restart.
CHECK LAST MAIL PIECE	Envelope has failed to open. <ul style="list-style-type: none">• Check the envelopes are loaded correctly.• Reload the envelopes and restart machine.
CLEAR FOLD PLATE	Material was detected inside the fold plate indicated on the display. <ul style="list-style-type: none">• Remove the fold plate and check for any material.• Install fold plate.
CLEAR INSERTION AREA	Material was detected in the inserting area. <ul style="list-style-type: none">• Open tinted plastic cover on left side of the inserter and remove any material.• Close the cover and restart the inserter.
CLEAR MOISTENER	Material is detected in the sealer brush area. <ul style="list-style-type: none">• Open the tinted plastic cover on left hand side of machine and remove any material.• Close cover and restart the inserter.

6 • Troubleshooting and Error Messages

Message	Action
CLEAR SEALER	Material is detected in the sealer brush area. <ul style="list-style-type: none">• Open the tinted plastic cover on left side of the inserter and remove any material.• Close cover and restart.
CLOSE COVER	Cover indicated is not fully closed. Close the indicated cover and restart the inserter.
CLOSE MAN ADV COVER	The manual advance knob door is not fully closed. Close the door.
DEFLECTOR ERROR	The function of half fold is not possible due to a fault. Remove fold plates and check for any material.
DOUBLE FEED	A double feed has been detected from the feed tray indicated. <ul style="list-style-type: none">• Remove the material from the inserter and restart.• If double feeds persist, request another trial piece.
DOUBLE FEED CHECK STACKER	A double feed has been detected from the feed tray indicated. <ul style="list-style-type: none">• Remove the double feed from the stacker• Restart the inserter.
FOLD PLATES NOT SET	The fold plates has not set to the correct position. <ul style="list-style-type: none">• Remove fold plates and check for any material.• Install the fold plates and restart the inserter.
MANUAL FEED TIMEOUT	Material feed has not been detected within a predetermined time. <ul style="list-style-type: none">• In manual feed mode, you must feed material within a set time.• Restart the machine by pressing Start.

Troubleshooting and Error Messages • 6

<i>Message</i>	<i>Action</i>
PAPER SHORT	<p>The inserter detected that the material used is too short in length.</p> <ul style="list-style-type: none">• Check the actual material length matches the length displayed.• If correct, request another trial piece.
PAPER SHORT CHECK STACKER	<p>The inserter detected that the material used is too short in length.</p> <ul style="list-style-type: none">• Check the actual material length matches the length displayed.• If correct, request another trial piece.
SET LEVER	<p>The manual feed lever is in the incorrect position for the mode of running.</p> <ul style="list-style-type: none">• Move the manual feed lever to the correct position (left position: manual; right: automatic).
STREAM FEED	<p>The inserter detected two sheets fed together from the feed tray indicated.</p> <ul style="list-style-type: none">• Remove the material from the inserter.• Reload and restart the inserter.
STREAM FEED CHECK STACKER	<p>The inserter detected two sheets fed together from the feed tray indicated.</p> <ul style="list-style-type: none">• Remove the stream feed from the stacker.• Reload and restart the inserter.
SYSTEM ERROR POWER DOWN	<p>A fault has been detected in the main software.</p> <ul style="list-style-type: none">• Switch the inserter off and on and retry.• If the problem persists, call for service.
TRAY EMPTY	<p>The tray indicated has no material. Reload the tray and press Start.</p>

This page is intentionally blank.

7 • *Material Specifications*

Contents

Material Specifications.....	7-3
Sheet Feeders	7-3
Insert Feeder.....	7-5
Sealer.....	7-5
Stacker.....	7-5
Material Requirements	7-5
Envelope Feeder.....	7-6
Inserter Specifications	7-8

This page is intentionally blank.

Material Specifications

Sheet Feeders

Sheet Sizes

	Minimum sheet size	Maximum sheet size
Width	5 inches (127mm)	9 inches (229mm)
Length	5 inches (127mm)	16 inches (406mm)

Paper Weights

	Minimum	Maximum
Non-OMR	16 lb. (60gsm)	32 lb. (120gsm)
OMR	18 lb. (70gsm)	32 lb. (120gsm)

Fold Configurations *(material length limits before folding)*

Fold Type	Measurement
Single fold	5 inches (127mm) - 12 inches (315mm)
C-fold <i>(letter fold)</i>	6 inches (150mm) - 14 inches (356mm)
Z-fold <i>(accordion fold)</i>	8 inches (201mm) - 14 inches (356mm)
Double fold	12 inches (305mm) - 16 inches (406mm)

Double Document Detector Material Range

Minimum	Maximum
16 lb. (60gsm)	32 lb. (120gsm)

Feed Tray Capacity

- Maximum of 100 sheets of 20 lb. bond (80gsm)

Manual Feed Mode

- Inserter processes stapled sets of up to five sheets of 20 lb. bond (80gsm) up to a maximum total weight of 100 lbs. (400gsm) per set.
NOTE: For manual feed applications, you may use only sheet feeder number 1, plus the insert feeder if required.
- Maximum compressed thickness after folding *must not* exceed 0.078 inch (2mm).
- We *do not* recommend the use of glossy/coated sheets.

7 • Material Specifications

Fold Type and Overall Thickness Limits

Check this table for the maximum number of sheets that can be accumulated/collated for each fold type.

IMPORTANT! Do not program jobs that exceed these maximums or impose them by OMR code printing and/or OMR selective feed.

Number of sheets	Paper Weights (lb /gsm)		
	16-20 lb (60-80 gsm)	20-26 lb (81-100 gsm)	26-32 lb (101-120 gsm)
1	C,Z,S,D	C,Z,S,D	C,Z,S,D
2	C,Z,S,D	C,Z,S,D	C,Z,S
3	C,Z,S,D	C,Z,S	C,Z,S
4	C,Z,S	C,Z,S	
5	C,Z,S		
Fold Types: C = C Fold, Z = Z Fold, S = Single Fold, D = Double Fold			

NOTES:

- You can use the sheet limits above with one additional sheet from the supplementary feeder plus one insert, *only* if total mail piece contents do not exceed 0.078 in. (2mm) total compressed thickness.
- For single fold only, using 16 lb. to 20 lb. (60-75gsm) paper only, you can place a maximum of 10 items in an envelope. This maximum includes any additional sheets from the supplementary feeder and/or insert feeder. The overall maximum compressed thickness of 0.078 in. (2mm) still applies.

Insert Feeder

Insert Sizes

	Minimum insert size	Maximum insert size
Width	5 inches (127mm)	9 inches (230mm)
Length	3.25 inches (82mm)	6 inches (152mm)

Paper Weights

	Minimum	Maximum
Non-folded cut sheet	20 lbs. (75gsm)	
Single sheet		50 lbs. (180gsm)
Folded material	16 lbs. (60gsm)	
Inserts of up to a maximum compressed thickness of 0.078 in. (2mm)		

NOTE: Pre-folded or single panel inserts should be fed from the insert feeder.

Double Document Detector Material Range

Minimum	Maximum
16 lbs. (60gsm)	32 lbs. (120gsm)

Feed Tray Capacity

- Up to a maximum of 100 inserts

Sealer

- Inserters seal up to a maximum of 1,200 envelopes between refills.

Stacker

- Envelope stackers accommodate up to 150 filled envelopes (*depending on size and contents of the envelope*).

Material Requirements

- For best performance, use only materials approved by Pitney Bowes
- Materials should be good quality and properly stored.
- Recommended storage conditions:
 - 65°F (18°) to 77°F (25°C)
 - 40% to 60% relative humidity

7 • Material Specifications

Envelope Feeder

Minimum Envelope Size

- Depth: 3.5 inches (88mm)
- Width: 8.5 inches (220mm)

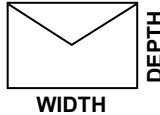

Maximum Envelope Size

- Depth: 6.5 inches (164mm)
- Width: 9.5 inches (242mm)

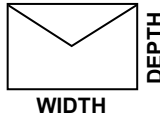

Envelope Weights

- Minimum: 17 lbs. (65gsm)
- Maximum: 26 lbs. (100gsm)

Envelope Tray Capacity

- Up to a maximum of 300 24 lb. (90gsm) envelopes.

End Clearance

- End clearance between insert and envelope - minimum of 0.236 inches (6mm) at each side
- Overall - a minimum of 0.472 inches (12mm)
- Take this measurement with all documents placed in the envelope

Depth Clearance

- Inserts (unfolded) - allow a minimum clearance of 0.118 inches (3mm), below the flap crease after it is fully inserted into the envelope.
- Inserts (folded) - allow a minimum clearance of 0.236 inches (6mm), below the flap crease after it is fully inserted into the envelope.

Envelope Flap and Throat Requirements

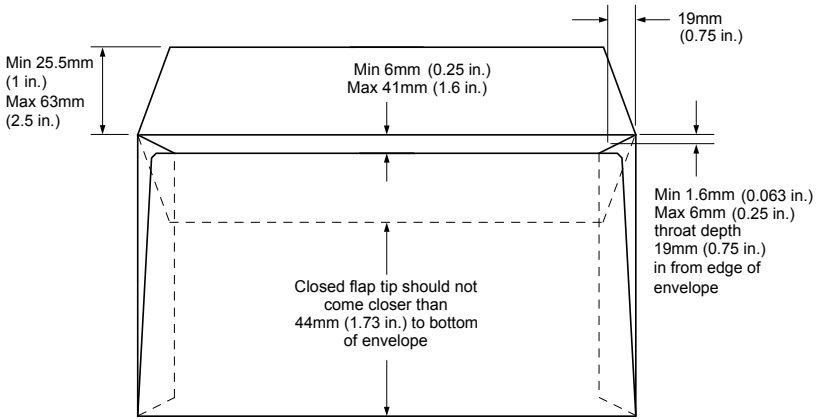

7 • Material Specifications

Inserters Specifications

Physical Dimensions

- Length - 30.4 inches (773mm)
- Depth - 22.3 inches (568mm)
- Height - 20.6 inches (525mm)
- Weight - 121 lbs.(55kg)

Noise Level

- 72dBA (*system running*)

Electrical

- USA and Canada: 120V, 60Hz, 6.0A
- Europe: 220/240V 50Hz
- Japan: 100V, 50/60Hz

Speed

Up to a maximum of 2,500 cycles per hour (*depending on inserter condition, operator skill, fold type, and material quality*)

Fold Modes

- Single fold
- C - Letter fold
- Z - Accordion fold
- Double fold

This page is intentionally blank.



3001 Summer Street
Stamford, CT 06926-0700
www.pitneybowes.com

SV63139 Rev. C
©2015 Pitney Bowes Inc.
All Rights Reserved